

**5236 W MERCER WAY**

**STORM DRAINAGE  
REPORT**

**Located at:**  
5236 W Mercer Way  
Mercer Island, WA

**Prepared For:**  
Joseph Greif AIA  
Greif Architects / Living Architecture  
921 NE Boat St.  
Seattle, WA 98105

**July 31, 2018**

**Prepared By:**

PACE Engineers, Inc.  
11255 Kirkland Way #300  
Kirkland, Washington 98033-6715  
p. 425.827.2014 f. 425.827.5043  
PACE Project No. 16513



## **5236 W MERCER WAY**

# **STORM DRAINAGE REPORT**

Prepared For:

Joseph Greif AIA  
Greif Architects / Living Architecture  
921 NE Boat St.  
Seattle, WA 98105

**July 31, 2018**

Prepared By:



Dan Westley, PE  
PACE Engineers, Inc.  
11255 Kirkland Way, Suite 300  
Kirkland, WA 98033  
p. 425.827.2014  
f. 425.827.5043



7/31/18

PACE Project No. 17387

## TABLE OF CONTENTS

1.	PROJECT OVERVIEW .....	3
2.	CORE REQUIREMENTS .....	3
2.1	MR #1 – Preparation of Stormwater Site Plans .....	3
2.2	MR #2 – Construction Stormwater Pollution Prevention .....	3
2.3	MR #3 – Source Control of Pollution .....	3
2.4	MR #4 – Preservation of Natural Drainage Systems and Outfalls .....	3
2.5	MR #5 – On-Site Stormwater management .....	3
2.6	MR #6 – Runoff Treatment .....	4
2.7	MR #7 – Flow Control .....	4
2.8	MR #8 – Wetlands Protection .....	4
2.9	MR #9 – Operation and Maintenance.....	4
3.	OFF-SITE ANALYSIS .....	4
4.	ON-SITE STORMWATER MANAGEMENT .....	5
4.1	DRAINAGE SYSTEM .....	5
4.2	DETENTION SYSTEM .....	5
5.	STORMWATER POLLUTION PREVENTION PLAN .....	6
6.	SPECIAL REPORTS AND STUDIES.....	7
7.	OTHER PERMITS .....	7
8.	OPERATIONS AND MAINTENANCE .....	7

### APPENDICES:

Appendix	Contents
A	Storm Drainage & TESC Plan
B	Downstream Flowpath Map & Photo Log
C	Operations and Maintenance Checklists
D	Reports – Geotechnical Engineering Report
E	Low Impact Development Infiltration Infeasibility on Mercer Island

## 1. PROJECT OVERVIEW

The 5236 W Mercer Way project proposes the development of a single family residence. The subject property is located at 5236 W Mercer Way, King County in the city of Mercer Island, WA on parcel #1924059324.

The existing subject property is approximately 37,350 SF, is primarily wooded and has no buildings or structures. The existing topography contains areas of steep slopes above 40% grade. A riverine wetland exists on the southern end of the site. The total disturbed site area is approximately 22,000 SF.

The developed site will consist of 2,450 SF of roof area, 4,000 SF of concrete driveway, and 1,600 SF of concrete sidewalk/patio for a total impervious area of 8,050 SF. New pervious surface will be approximately 9,030 SF of lawn/grass surface. Approximately 2,300 SF of the site will remain undisturbed.

## 2. CORE REQUIREMENTS

The project will comply with the 2012 Stormwater management Manual for Western Washington, as Amended in December 2014, from the Department of Ecology (2014 SWMMWW). Per Chapter 2 of the 2014 SWMMWW, the project is required to comply with Minimum Requirement #1-9. Below are the Minimum Requirements and how the project meets each requirement.

### 2.1 MR #1 – PREPARATION OF STORMWATER SITE PLANS

Erosion and sediment control (ESC), grading, and storm drainage plans have been prepared and are included in Appendix A.

### 2.2 MR #2 – CONSTRUCTION STORMWATER POLLUTION PREVENTION

The proposed project disturbs less than 1 acre. An erosion and sediment control plan is included in Appendix A. The narrative for the 13 elements of the SWPPP is outlined in Section 5 of this report.

### 2.3 MR #3 – SOURCE CONTROL OF POLLUTION

Source controls are not applicable for residential projects.

### 2.4 MR #4 – PRESERVATION OF NATURAL DRAINAGE SYSTEMS AND OUTFALLS

The project's natural downstream drainage path routes to the northwesterly direction through a series of conveyance pipe and a natural watercourse. The proposed downstream flow path and site discharge location will remain preserved as in the existing condition.

### 2.5 MR #5 – ON-SITE STORMWATER MANAGEMENT

Low Impact Development (LID) facilities are not feasible due to a municipal restriction on infiltration LID facilities in this specific geographical location. As feasible, disturbed landscape soils will be amended per BMP T5.13. Per City of Mercer Island municipal code section 15.09.050.A.2, on-site detention BMP is

required and added to list No. 1 and 2 for MR #5. On-site detention BMP is provided by two onsite detention tanks sized per the City's standard detention pipe design table (based on the 1992 Stormwater Management Manual for Puget Sound Basin).

## **2.6 MR #6 – RUNOFF TREATMENT**

Runoff treatment is not required since the project will have less than 5,000 square feet of pollution generating impervious surfaces. Per City of Mercer Island standards, a catch basin with oil separator is proposed to provide oil water separation for all onsite road and parking stormwater runoff.

## **2.7 MR #7 – FLOW CONTROL**

Per City of Mercer Island municipal code section 15.09.050.A.2, on-site detention BMP is required and added to MR #5 requirements. Per 2014 SWMMWW, Flow Control is not required as the net increase in runoff does not exceed 0.15 cfs. In this circumstance, City of Mercer Island Code governs the stormwater flow control design and flow control on-site detention is required for all hardscape surfaces. Refer to section 2.5 for a design summary of the proposed on-site detention BMP.

## **2.8 MR #8 – WETLANDS PROTECTION**

Not applicable. No wetlands are located on or near the site.

## **2.9 MR #9 – OPERATION AND MAINTENANCE**

Operations and maintenance will be required for onsite storm drainage components. See Section 8 of this report.

# **3. OFF-SITE ANALYSIS**

Upstream runoff enters the project site along the eastern property boundary. The tributary upstream basin is approximately 0.40 acres in size. A large portion of the upstream basin flows are tributary to the wetland/open channel system located along the southern property boundary of the subject property. An insignificant amount of overland flow is conveyed overland onto the subject property and continues as overland flow in the westerly direction.

Downstream flows discharge the site along the Western property boundary and enter the roadside ditch along West Mercer Way, conjoining with adjacent basin flows. Combined roadside ditch flows enter a 12" concrete culvert and are conveyed to the northwest, crossing West Mercer Way and enter a catch basin (CB). Flows continue in the northwesterly direction via 12" concrete storm drain pipe, entering a CB and then are released to a well-defined open channel watercourse conveyance system. The open channel flows continue in the northwesterly direction for approximately 600 LF and then head due west via open channel flow for approximately 300 LF. Open channel flows inlet a 24" concrete culvert and are conveyed to a nearby CB located approximately 200 LF

to the west. Flows outlet the CB via a 30" corrugated metal pipe, are conveyed for approximately 150 LF, and outlet into Lake Washington.

A photo log of the downstream assessment is provided in Appendix C. Please reference the Downstream Analysis Map for respective locations of the field photos.

## 4. ON-SITE STORMWATER MANAGEMENT

### 4.1 LID FEASIBILITY

The On-Site Stormwater Management requirement will be met by evaluating feasibility of each BMP in List #2 of 2014 SWMMWW Section I.2.5.5 for each type of surface on the project site.

#### 4.1.1 Lawn/Grass

Post Construction Soil Quality and Depth will be applied to proposed lawn and landscape areas in accordance with BMP T5.13.

#### 4.1.2 Impervious Surfaces (Roof, Driveway, and Sidewalk)

All BMPs in List #2 are infeasible for the project because they involve either infiltration or dispersion. Dispersion is infeasible because the project site does not have a native vegetation flow path of at least 100 feet in length containing grades less than 20%. Infiltration is infeasible due to a municipal restriction on LID facilities involving infiltration for this specific geographical location (see appendix D – City of Mercer Island Low Impact Development Infiltration Feasibility). No remaining List #2 items are feasible.

### 4.2 DETENTION SYSTEM

On-site detention BMP is required per City of Mercer Island municipal code section 15.09.050.A.2 because the subject property is tributary to a natural downstream watercourse. The on-site detention system sizing method used is based on the 1992 DOE Stormwater Management Manual for Puget Sound Basin per direction provided by City of Mercer Island Senior Development Engineer.

On-site detention BMP is provided by two onsite detention tanks sized per the City's standard detention pipe design table (based on the 1992 Stormwater Management Manual for Puget Sound Basin). The eastern basin detention pipe will provide flow control detention pipe volume for the roof, patio and driveway parking hardscape surface. The remaining driveway hardscape runoff will be routed to the western basin flow control detention pipe facility. A flow control basin map has been provided in Appendix A.

### 4.3 CONVEYANCE

Conveyance design relies on conservative design for 6" PVC storm drain pipe containing slopes no less than 2.0%. Under this condition, conveyance capacity is nearly 0.9 cfs. Tributary developed 100-year peak flows will not exceed 0.9 cfs under any circumstance.

## 5. STORMWATER POLLUTION PREVENTION PLAN

A Construction Stormwater General Permit and full SWPPP is not required for the project since less than 1-acre of land will be disturbed. A Narrative and Temporary Erosion and Sediment Control (TESC) Plan is required and has been prepared and is packaged with the Civil Engineering Plans. The narrative for the 13 elements are listed below with a short description of how each element is met.

1. Mark Clearing Limits

Orange construction fence or silt fence will be used along the clearing and grading limits which are defined on the TESC Plan. This is listed as one of the first steps in the construction sequence.

2. Establish Construction Access

A construction entrance with quarry spalls and geo-textile fabric is called out on the TESC Plan. Access will be from W Mercer Way at the proposed driveway location.

3. Control Flow Rates

A small sediment trap will provide control of flow rates for construction runoff during construction.

4. Install Sediment Controls

Sediment controls will be installed prior to any grading activities. Installation of the sediment controls shall be per the construction sequence shown on the TESC Plans. Silt fence will be the primary method of sediment control.

5. Stabilize Soils

Temporary ground cover will include plastic sheeting or mulch. Any soils that will be exposed long-term, over 30 days, will be sprayed with hydroseed and allowed to grow prior to the wet season.

6. Protect Slopes

Slopes will be protected with plastic sheeting or mulch.

7. Protect Drain Inlets

Storm drain inlet protection will be installed in catch basins in the vicinity of the project site.

8. Stabilize Channels and Outlets

Straw wattles and compost socks will be used to stabilize channels. The outlet is a hard pipe so stabilization of outlet will not be required.

9. Control Pollutants

Construction equipment will be kept in good working order to prevent oil drippings.

10. Control De-Watering

Any de-watering activities will be directed to the proposed sediment trap to remove sediments. The detention will be cleaned once the site is stabilized.

11. Maintain BMP's

The CESCL or Monitoring Personnel shall be responsible for keeping track of construction BMP's.

12. Manage the Project

The contractor, CESCL, and parties involved shall be mindful of construction activities, the time of year, and to maintain TESC facilities to function as designed.

13. Protect Low Impact Development BMPs

N/A. There are no LID BMPs proposed for the project.

## 6. SPECIAL REPORTS AND STUDIES

- *Geotechnical Engineering Report* dated October 5, 2017 by PanGEO Inc. See Appendix D in this report for a copy of the study.

## 7. OTHER PERMITS

- Building Permit (City of Mercer Island)
- Right-of-Way Permit (City of Mercer Island)
- Water and Sewer Connection Permits (City of Mercer Island)

## 8. OPERATIONS AND MAINTENANCE

O & M Checklists from the 2014 SWMMWW have been inserted into Appendix C of this Report.



## APPENDIX A

### STORM DRAINAGE AND TESC PLAN

FILE NAME: P:\P17387\17387\_5236 WEST MERCER WAY SFR\CAD\ENGINEERING\17387-GP.DWG  
 SAVE TIME: 7/31/2018 10:09 AM  
 PLOT TIME: 7/31/2018 2:07 PM  
 USER NAME: MICHAEL PARKER  
 XREF FILES: X17387-TBLOCK.dwg X17387-SRV.dwg X17387-PROF.dwg X17387-ALIGN.dwg X17387-HA.dwg X17387-SP.dwg X17387-FG.dwg X17387-SD.dwg

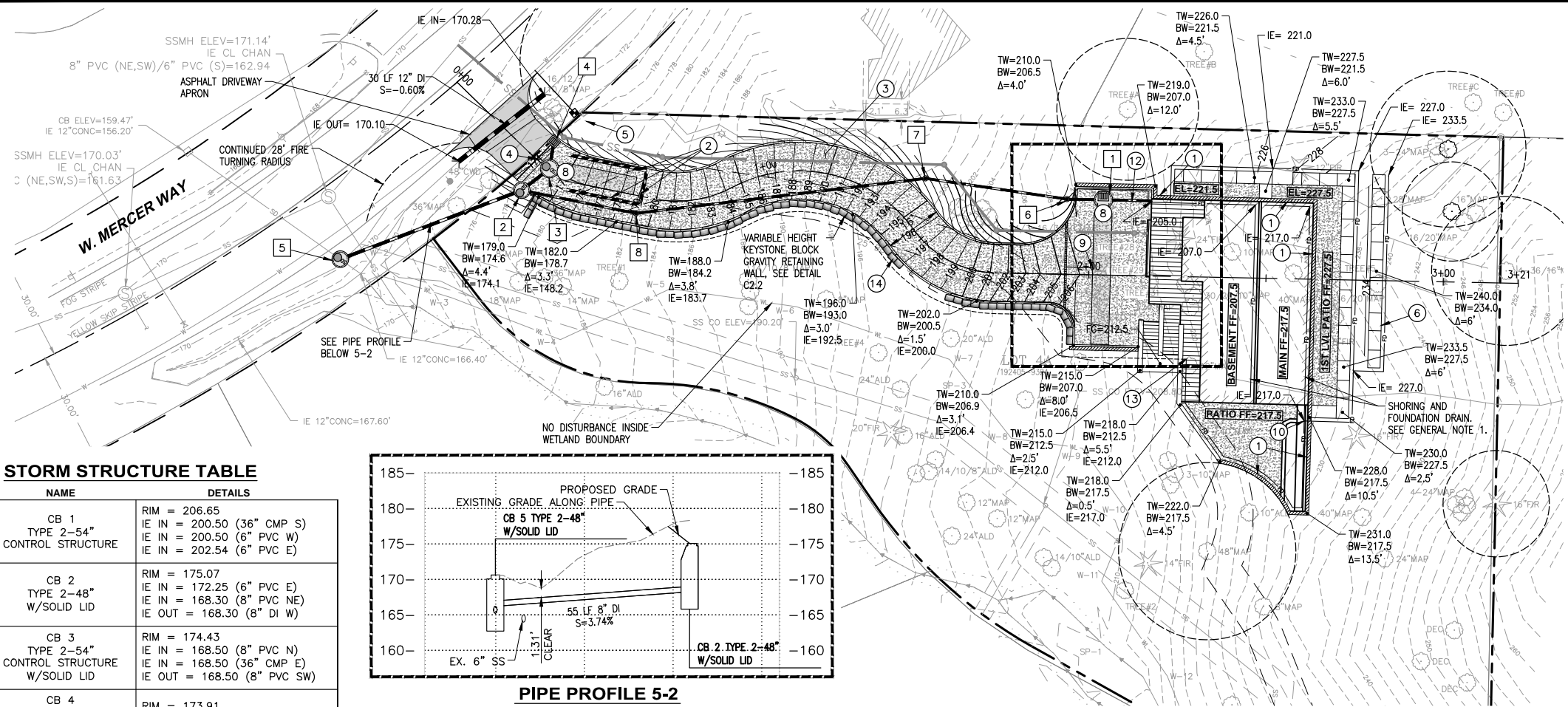

**STORM STRUCTURE TABLE**

NAME	DETAILS
1 CB 1 TYPE 2-54" CONTROL STRUCTURE	RIM = 206.65 IE IN = 200.50 (36" CMP S) IE IN = 200.50 (6" PVC W) IE IN = 202.54 (6" PVC E)
2 CB 2 TYPE 2-48" W/SOLID LID	RIM = 175.07 IE IN = 172.25 (6" PVC E) IE IN = 168.30 (8" PVC NE) IE OUT = 168.30 (8" DI W)
3 CB 3 TYPE 2-54" CONTROL STRUCTURE W/SOLID LID	RIM = 174.43 IE IN = 168.50 (8" PVC N) IE IN = 168.50 (36" CMP E) IE OUT = 168.50 (8" PVC SW)
4 CB 4 TYPE 1 W/OIL WATER SEPARATOR	RIM = 173.91 IE OUT = 168.50 (8" PVC S)
5 CB 5 TYPE 2-48" W/SOLID LID	RIM = 170.62 IE IN = 166.25 (8" DI E) IE IN = 165.21 (12" CONC SE) IE OUT = 165.21 (12" CONC NW)
6 CO 1 SDCO	RIM = 207.55 IE OUT = 200.40 (6" PVC E) IE OUT = 200.40 (6" PVC W)
7 CO 2 SDCO	RIM = 196.47 IE IN = 190.50 (6" PVC E) IE OUT = 190.50 (6" PVC W)
8 CO 3 SDCO	RIM = 179.14 IE IN = 176.64 (6" PVC E) IE OUT = 176.64 (6" PVC W)

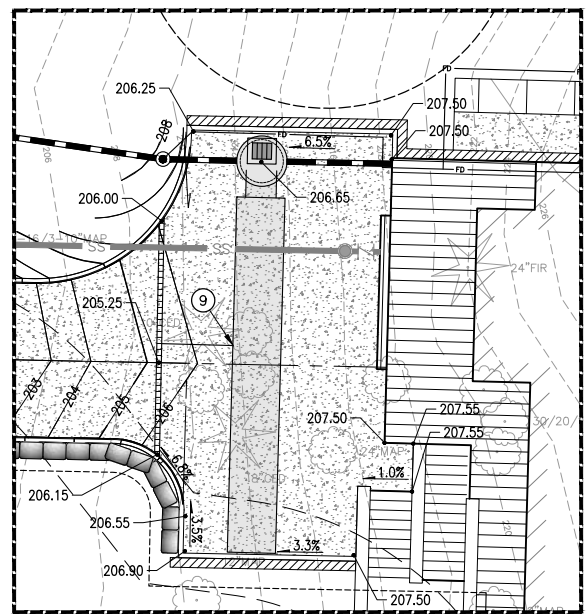
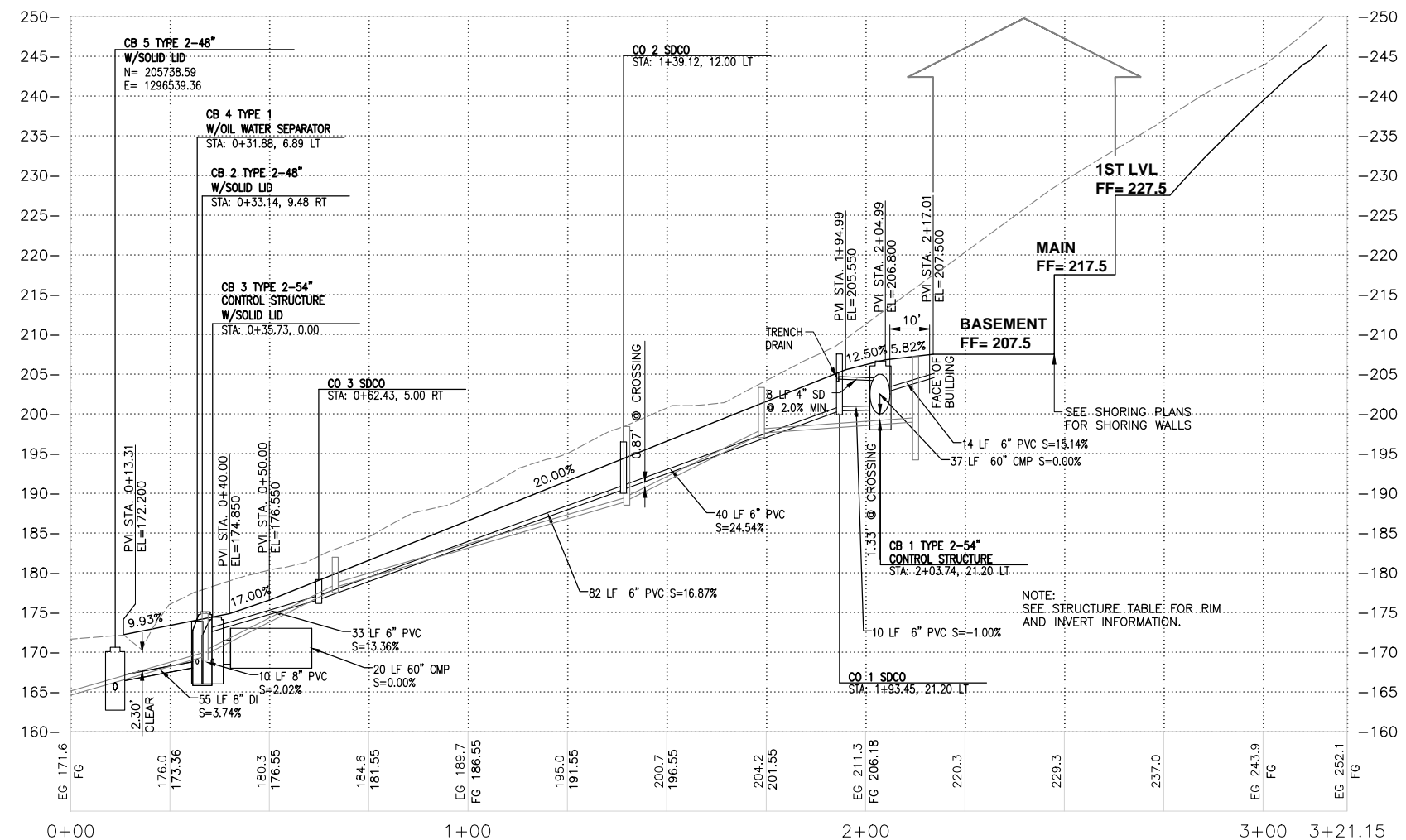
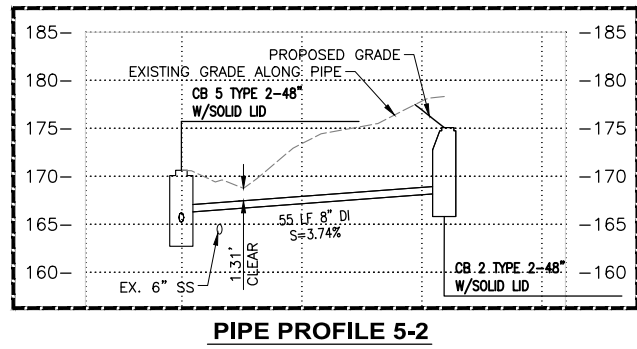

**DRIVEWAY GRADING**  
1"=10'

**KEY NOTES**

- PERMANENT SHORING WALLS
- TEMPORARY SHORING WALLS
- CONCRETE DRIVEWAY WITH VERTICAL CURB AND GUTTER.
- VALLEY GUTTER AT EDGE OF ASPHALT. SEE DETAIL 3, SHEET C2.1.
- 1" WATER METER, MINIMUM.
- GABION BASKET WALL (TYP), SEE DETAIL 4, SHEET C2.1.
- NOT USED.
- CMP DETENTION PIPE, SEE DETAILS ON SHEET C2.1.
- CONNECT TRENCH DRAIN TO DETENTION SYSTEM VIA 4" SD GRAVITY DRAIN @ 2.0% MINIMUM SLOPE. TRENCH DRAIN FINISHED GRADE ELEVATION MUST NOT BE LESS THAN 205.25.
- CONNECT GABION BASKET WALL FOOTING DRAINS TO SOLDIER PILE SHORING FOOTING DRAIN.
- CONNECT WALL DRAIN TO CB.
- 6" ROOF DRAIN OUTLET, S=2.00% MIN.
- CONNECT FOOTING DRAIN TO WALL DRAIN.
- FINAL WALL DESIGN SHALL BE COMPLETED BY THE BLOCK WALL MANUFACTURER, BASED ON GEOTECHNICAL PARAMETERS PRESENTED IN THE GEOTECHNICAL REPORT, SECTION 6.6.

**GENERAL NOTES:**

- REFERENCE SHORING AND STRUCTURAL DETAILS FOR SHORING AND FOUNDATION DRAIN OUTLET DETAILS.
- BASEMENT FLOOR SHORING-FOUNDATION DRAIN OUTLET SD @ 2.0% MIN.
- YARD DRAIN OUTLET SD @ 2.0% MIN
- STORM CONVEYANCE PIPE SHALL BE SDR 35 PVC.
- GABION BASKET WALL CONSTRUCTED PRIOR TO PERMANENT SHORING CONSTRUCTION. SEE SHORING AND STRUCTURAL PLANS.
- BMP T5.13 POST CONSTRUCTION SOIL QUALITY AND DEPTH OR BETTER FOR ALL DISTURBED LANDSCAPE AREAS.

**LEGEND**

- PERMANENT SHORING
- TEMP. SHORING
- SANITARY SIDE SEWER
- SS CLEANOUT
- STORM DRAIN
- TRENCH DRAIN
- FOOTING DRAIN
- WALL DRAIN
- SD CLEANOUT
- YARD DRAIN
- CB TYPE 1
- CB TYPE 2
- CAST-IN-PLACE WALL

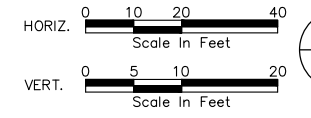

**CALL BEFORE YOU DIG 8-11**  
UNDERGROUND SERVICE (USA)

**PACE**  
An Engineering Services Company  
11255 Kirkland Way, Suite 300  
Kirkland, WA 98033  
P. 425.827.2014 | F. 425.827.5043  
Civil | Structural | Planning | Survey |  
paceeng.com

**EDWARD W. PARKER**  
REGISTERED PROFESSIONAL ENGINEER  
NO. 34340  
07/31/18

**5236 W MERCER WAY**  
**SINGLE FAMILY RESIDENCE**  
**ROAD, GRADING, AND STORM PLAN**

SCALE: AS SHOWN  
DATE: 07/31/2018  
DESIGNED BY: DW  
CHECKED BY: JS  
JOB NUMBER: 17387  
SHEET: **C2.0**  
SHEET 6 OF 11

**LEGEND**

- SILT FENCE
- CONSTRUCTION LIMITS AND TREE PROTECTION CHAIN LINK FENCE
- INTERCEPTOR SWALE
- TEMPORARY CONSTRUCTION ENTRANCE
- INLET PROTECTION
- TREE PROTECTION LIMITS
- DRIVEWAY BASE COURSE OR ATB PRELEVEL

**GENERAL NOTES:**

1. TREE REMOVAL TO BE COORDINATED WITH ARBORIST AND THE CITY OF MERCER ISLAND.

**CONSTRUCTION SEQUENCE**

1. INSTALL CONSTRUCTION LIMITS AND TREE PROTECTION CHAIN LINK FENCE, ALONG IDENTIFIED CONSTRUCTION LIMITS.
2. INSTALL PERMANENT DOWNSTREAM PIPED CONVEYANCE INCLUDING CB5 AND CB2. SEE SHEET C2.0.
3. INSTALL STORM DRAIN INLET PROTECTION.
4. GRADE AND INSTALL CONSTRUCTION ENTRANCE AND PERMANENT DRIVEWAY CULVERT.
5. GRADE AND INSTALL CONSTRUCTION STAGING / PARKING AREA.
6. GRADE AND DESIGNATE STOCKPILE AREAS.
7. INSTALL TEMPORARY INTERCEPTOR SWALE AND SEDIMENT CONTROL MEASURES.
8. BEGIN DRIVEWAY CLEARING AND GRADING.
9. INSTALL UTILITIES LOCATED IN DRIVEWAY CORRIDOR.
10. INSTALL DRIVEWAY, GRADE WALLS, DRIVEWAY ACCESS BASE COURSE OR ATB PRELEVEL.
11. INSTALL GABION BASKET WALLS.
12. INSTALL BUILDING FOUNDATION SHORING.
13. CONSTRUCT BUILDING AND REMAINING HARDSCAPE FEATURES.
14. CONNECT UTILITIES.
15. STABILIZE SITE.
16. REMOVE REMAINING TESC FEATURES.
17. CONDUCT ALL ACTIVITIES IN ACCORDANCE WITH ESC NOTES, THIS SHEET.

**BMP T5.13 IMPLEMENTATION NOTES:**

1. Leave undisturbed native vegetation and soil, and protect from compaction during construction.
2. Amend existing site topsoil or subsoil either at default "pre-approved" rates, or at custom calculated rates based on tests of the soil and amendment.
3. Stockpile existing topsoil during grading, and replace it prior to planting. Stockpiled topsoil must also be amended if needed to meet the organic matter or depth requirements, either at a default "pre-approved" rate or at a custom calculated rate.
4. Import topsoil mix of sufficient organic content and depth to meet the requirements.
5. More than one method may be used on different portions of the same site. Soil that already meets the depth and organic matter quality standards, and is not compacted, does not need to be amended.

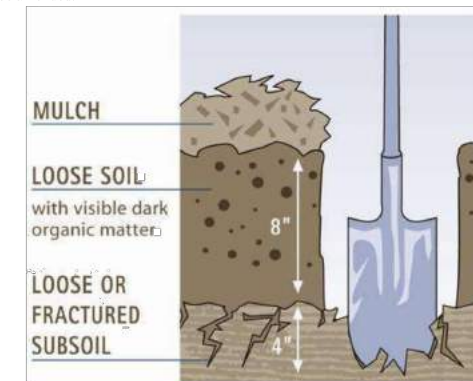

**1** DETAILS



HORIZ. 0 10 20 40  
Scale In Feet

**CALL BEFORE YOU DIG 8-11**  
UNDERGROUND SERVICE (USA)

**EROSION AND SEDIMENTATION CONTROL NOTES:**

1. APPROVAL OF THIS EROSION AND SEDIMENTATION CONTROL (ESC) PLAN DOES NOT CONSTITUTE AN APPROVAL OF PERMANENT ROAD OR DRAINAGE DESIGN (E.G. SIZE AND LOCATION OF ROADS, PIPES, RESTRICTORS, CHANNELS, RETENTION FACILITIES, UTILITIES, ETC.)
2. THE IMPLEMENTATION OF THESE ESC PLANS AND THE CONSTRUCTION, MAINTENANCE, REPLACEMENT, AND UPGRADING OF THESE ESC FACILITIES IS THE RESPONSIBILITY OF THE APPLICANT/ESC SUPERVISOR UNTIL THE SITE IS STABILIZED.
3. THE BOUNDARIES OF THE CLEARING LIMITS SHOWN ON THIS PLAN SHALL BE CLEARLY FLAGGED BY SURVEY TAPE OR FENCING, IF REQUIRED, PRIOR TO CONSTRUCTION (SWDM APPENDIX D). DURING THE CONSTRUCTION PERIOD, NO DISTURBANCE BEYOND THE CLEARING LIMITS SHALL BE PERMITTED. THE CLEARING LIMITS SHALL BE MAINTAINED BY THE APPLICANT/ESC SUPERVISOR FOR THE DURATION OF CONSTRUCTION.
4. STABILIZED CONSTRUCTION ENTRANCES SHALL BE INSTALLED AT THE BEGINNING OF CONSTRUCTION AND MAINTAINED FOR THE DURATION OF THE PROJECT. ADDITIONAL MEASURES, SUCH AS CONSTRUCTED WHEEL WASH SYSTEMS OR WASH PADS, MAY BE REQUIRED TO ENSURE THAT ALL PAVED AREAS ARE KEPT CLEAN AND TRACK OUT TO ROAD RIGIDITY OF WAY DOES NOT OCCUR FOR THE DURATION OF THE PROJECT.
5. THE ESC FACILITIES SHOWN ON THIS PLAN MUST BE CONSTRUCTED PRIOR TO OR IN CONJUNCTION WITH ALL CLEARING AND GRADING SO AS TO ENSURE THAT THE TRANSPORT OF SEDIMENT TO SURFACE WATERS, DRAINAGE SYSTEMS, AND ADJACENT PROPERTIES IS MINIMIZED.
6. THE ESC FACILITIES SHOWN ON THIS PLAN ARE THE MINIMUM REQUIREMENTS FOR ANTICIPATED SITE CONDITIONS. DURING THE CONSTRUCTION PERIOD, THESE ESC FACILITIES SHALL BE UPGRADED AS NEEDED FOR UNEXPECTED STORM EVENTS AND MODIFIED TO ACCOUNT FOR CHANGING SITE CONDITIONS (E.G. ADDITIONAL COVER MEASURES, RELOCATION OF DITCHES AND SILT FENCES, PERIMETER PROTECTION ETC.).
7. THE ESC FACILITIES SHALL BE INSPECTED DAILY BY THE APPLICANT/ESC SUPERVISOR AND MAINTAINED TO ENSURE CONTINUED PROPER FUNCTIONING. WRITTEN RECORDS SHALL BE KEPT OF WEEKLY REVIEWS OF THE ESC FACILITIES.
8. ANY AREAS OF EXPOSED SOILS, INCLUDING ROADWAY EMBANKMENTS, THAT WILL NOT BE DISTURBED FOR TWO DAYS DURING THE WET SEASON OR SEVEN DAYS DURING THE DRY SEASON SHALL BE IMMEDIATELY STABILIZED WITH THE APPROVED ESC COVER METHODS (E.G., SEEDING, MULCHING, PLASTIC COVERING, ETC.).
9. ANY AREA NEEDING ESC MEASURES, NOT REQUIRING IMMEDIATE ATTENTION, SHALL BE ADDRESSED WITHIN SEVEN (7) DAYS.
10. THE ESC FACILITIES ON INACTIVE SITES SHALL BE INSPECTED AND MAINTAINED A MINIMUM OF ONCE A MONTH OR WITHIN 24 HOURS FOLLOWING A STORM EVENT.
11. AT NO TIME SHALL MORE THAN ONE (1) FOOT OF SEDIMENT BE ALLOWED TO ACCUMULATE WITHIN A CATCH BASIN. ALL CATCH BASINS AND CONVEYANCE LINES SHALL BE CLEANED PRIOR TO PAVING. THE CLEANING OPERATION SHALL NOT FLUSH SEDIMENT-LADEN WATER INTO THE DOWNSTREAM SYSTEM.
12. COVER MEASURES WILL BE APPLIED IN CONFORMANCE WITH APPENDIX D OF THE SURFACE WATER DESIGN MANUAL.
13. PRIOR TO THE BEGINNING OF THE WET SEASON (OCT. 1), ALL DISTURBED AREAS SHALL BE REVIEWED TO IDENTIFY WHICH ONES CAN BE SEEDED IN PREPARATION FOR THE WINTER RAINS. DISTURBED AREAS SHALL BE SEEDED WITHIN ONE WEEK OF THE BEGINNING OF THE WET SEASON. A SKETCH MAP OF THOSE AREAS TO BE SEEDED AND THOSE AREAS TO REMAIN UNCOVERED SHALL BE SUBMITTED TO THE DDES INSPECTOR FOR REVIEW.

FILE NAME: P:\P171387\_5236 WEST MERCER WAY SFR\CAD\ENGINEERING\ SHEETS\P17387 - TESC.DWG  
SAVE TIME: 7/31/2018 9:11:13 AM  
PLOT TIME: 7/31/2018 2:06 PM  
USER NAME: MICHAEL PARKER  
XREF FILES: X17387-TBLOCK.dwg X17387-SRV.dwg X17387-SP.dwg X17387-EG.dwg X17387-SD.dwg X17387-DRIPLINES.dwg

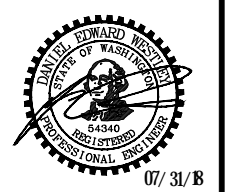

**5236 W MERCER WAY**  
**SINGLE FAMILY RESIDENCE**  
**TESC AND CONSTRUCTION**  
**MANAGEMENT PLAN**

SCALE:	DATE:
AS SHOWN	07/31/2018
DESIGNED BY:	CHECKED BY:
DW	JS
JOB NUMBER	17387
SHEET:	<b>C1.0</b>
SHEET <b>4</b> OF <b>11</b>	

DATE  
REVISION  
SYM

## APPENDIX B

### DOWNSTREAM ANALYSIS MAP & PHOTO LOG

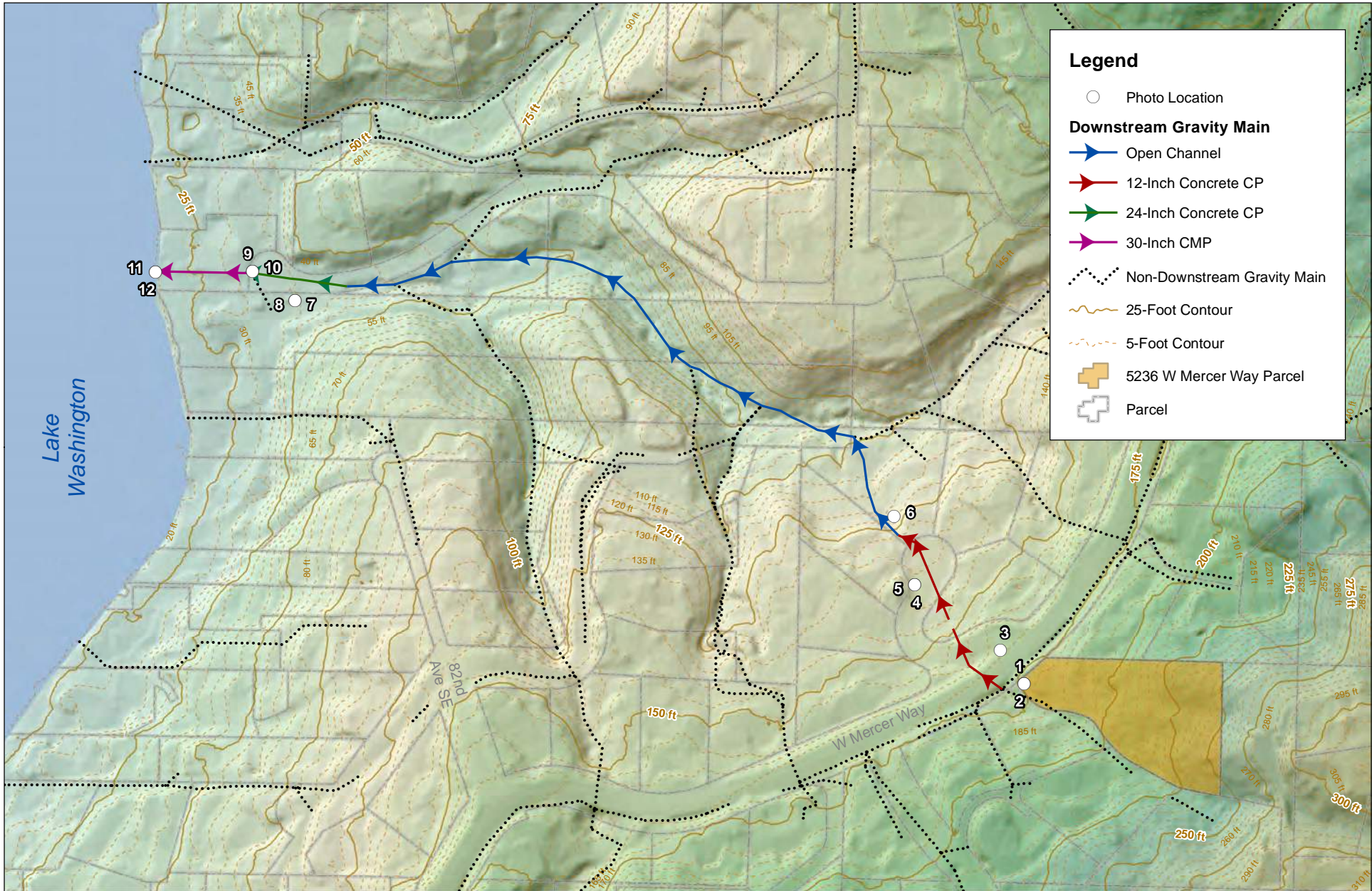

**Legend**

- Photo Location
- Downstream Gravity Main**
  - ▶ Open Channel
  - ▶ 12-Inch Concrete CP
  - ▶ 24-Inch Concrete CP
  - ▶ 30-Inch CMP
- ⋯ Non-Downstream Gravity Main
- 25-Foot Contour
- - - 5-Foot Contour
- ⊕ 5236 W Mercer Way Parcel
- Parcel



## Downstream Analysis Map

5236 W Mercer Way, Mercer Island, WA

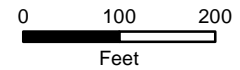

Note: These layers represent themes requiring further planning and design. They are conceptual and under no circumstances should be construed as final plans for specific sites or areas.



Image 1: Onsite runoff enters W Mercer Way roadside ditch



Image 2: Downstream flows are conveyed northwesterly, crossing W Mercer Way via 12" concrete culvert



Image 3: Flows enter this CB located just northwest of W Mercer Way



Image 4: Downstream flows are conveyed to this CB via a 12" concrete pipe



Image 5: Concrete pipe conveys flows through this CB



Image 6: Downstream flows outlet to this open channel private watercourse located at 5200 W Mercer Pl





Image 7: Downstream flows are conveyed through this well-defined and protected open channel



Image 8: Open channel flows inlet this 24" concrete culvert



Image 9: 24" concrete culvert pipe enters this CB and flows continue in the westerly direction via 30" corrugated aluminum pipe through a private drainage easement located at 5067 SE 51<sup>st</sup> St



Image 10: flows outlet the CB via a 30" corrugated aluminum pipe



Image 11: Flows outlet the 30" corrugated aluminum pipe and enter Lake Washington



Image 12: Downstream flows outfall into Lake Washington at 5067 SE 51<sup>st</sup> St

## APPENDIX C

### OPERATIONS & MAINTENANCE

## APPENDIX D

## REPORTS

# GEOTECHNICAL ENGINEERING REPORT

## PROPOSED RESIDENCE

### 5236 WEST MERCER WAY

### MERCER ISLAND, WASHINGTON

Project No. 17-143.200  
October 5, 2017

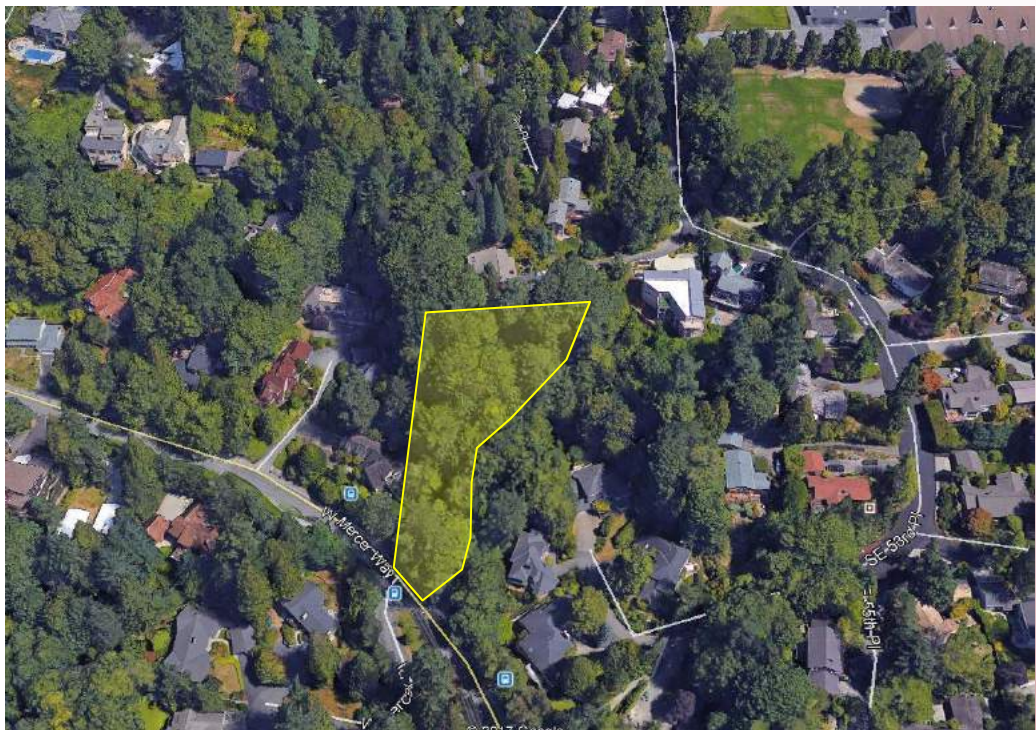

*Credit: Google Earth*

Prepared for:  
**The Mills Family**



3213 Eastlake Avenue East, Ste B  
Seattle, Washington 98102-7127  
Tel: 206.262.0370 Fax: 206.262.0374

*Geotechnical & Earthquake  
Engineering Consultants*

October 5, 2017  
PanGEO Project No. 17-143.200

**The Mills Family**

c/o Mr. Joseph Greif  
Greif Architects / Living Architecture  
921 NE Boat Street  
Seattle, Washington 98105

**Subject: Geotechnical Engineering Report  
Proposed Residence  
5236 West Mercer Way  
Mercer Island, Washington 98125**

Dear Mr. Greif:

As requested, PanGEO has completed a geotechnical engineering study for the proposed single-family residence at the above address. In preparing this report, we performed a reconnaissance of the site, drilled six test borings at and adjacent to the site, and conducted engineering analyses. The results of our study and our design recommendations are presented in the attached report.

In summary, the proposed house footprint is underlain by medium dense to very dense silty sand at shallow depths. In our opinion, the new structure may be supported by a conventional shallow foundation system. A soldier pile wall represents a feasible excavation support system to allow for the construction of the proposed house basement while maintaining stability of the site.

We appreciate the opportunity to be of service. Should you have any questions, please do not hesitate to call.

Sincerely,

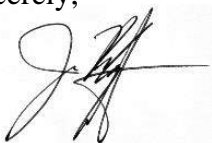

Jon C. Rehkopf, P.E.  
Senior Project Geotechnical Engineer

## TABLE OF CONTENTS

<u>Section</u>	<u>Page</u>
1.0 GENERAL .....	1
2.0 SITE AND PROJECT DESCRIPTION .....	1
3.0 SUBSURFACE EXPLORATIONS .....	3
4.0 SUBSURFACE CONDITIONS .....	3
4.1 SITE GEOLOGY .....	3
4.2 SOIL CONDITIONS .....	4
4.3 GROUNDWATER CONDITIONS .....	5
5.0 GEOLOGIC HAZARDS ASSESSMENT .....	5
5.1 POTENTIAL LANDSLIDE HAZARDS .....	5
5.2 SEISMIC HAZARDS .....	6
5.3 EROSION HAZARDS .....	6
6.0 GEOTECHNICAL RECOMMENDATIONS .....	7
6.1 SEISMIC DESIGN PARAMETERS .....	7
6.2 SPREAD FOOTINGS .....	7
6.2.1 Allowable Bearing Pressure .....	8
6.2.2 Lateral Resistance .....	8
6.2.3 Perimeter Footing Drains .....	8
6.2.4 Footing Subgrade Preparation .....	9
6.3 FLOORS SLABS .....	9
6.4 BASEMENT WALL DESIGN PARAMETERS .....	10
6.4.1 Lateral Earth Pressures .....	10
6.4.2 Lateral Resistance .....	10
6.4.3 Wall Backfill .....	11
6.4.4 Wall Drainage & Damp Proofing .....	11
6.5 DRIVEWAY PAVEMENT .....	12
6.6 DRIVEWAY RETAINING WALLS .....	12
6.6.1 Gravity Wall .....	13
6.6.2 Wall Backfill and Drainage Considerations .....	14
7.0 CONSTRUCTION CONSIDERATIONS .....	14
7.1 TEMPORARY UNSUPPORTED EXCAVATIONS .....	14
7.2 TEMPORARY EXCAVATION SHORING .....	15
7.2.1 Soldier Pile Wall .....	15
7.2.2 Design Lateral Pressures .....	15
7.2.3 Permanent Wall Considerations .....	16
7.2.4 Soldier Pile Installation Considerations .....	16
7.3 GROUNDWATER CONTROL .....	16
7.4 MATERIAL REUSE .....	17
7.5 STRUCTURAL FILL AND COMPACTION .....	17
7.6 WET WEATHER CONSTRUCTION .....	18
7.7 EROSION CONSIDERATIONS .....	18
8.0 ADDITIONAL SERVICES .....	19
9.0 CLOSURE .....	19
10.0 REFERENCES .....	21



**Table of Contents (Cont.)**

**ATTACHMENTS:**

- Figure 1 Vicinity Map
- Figure 2 Site and Exploration Plan
- Figure 3 Generalized Subsurface Profile Section A-A'
- Figure 4 Design Lateral Parameters – Cantilevered Soldier Pile Wall

**APPENDIX A – TEST BORING LOGS**

- Figure A-1 - Terms and Symbols for Boring and Test Pit Logs
- Figures A-2 through A-7 - Logs of Test Borings PG-1 through PG-6

**GEOTECHNICAL ENGINEERING REPORT**  
**PROPOSED RESIDENCE**  
**5236 WEST MERCER WAY**  
**MERCER ISLAND, WASHINGTON**

---

**1.0 GENERAL**

PanGEO, Inc. is pleased to present the following geotechnical engineering report to assist the project team with the design and permitting of the proposed residence at 5236 West Mercer Way, in Mercer Island, Washington. This study was prepared in general accordance with our mutually agreed scope of services outlined in our proposal dated April 24, 2017, which was approved on May 1, 2017. Our scope of services included reviewing readily available geologic and geotechnical data, conducting a site reconnaissance, advancing test borings at the site, conducting engineering analyses, and preparing the following geotechnical report.

**2.0 SITE AND PROJECT DESCRIPTION**

The subject site is located at 5236 West Mercer Way, in Mercer Island, Washington, as shown on Figure 1, Vicinity Map. The site consists of an irregularly shaped parcel that measures a maximum of about 260 feet in the east-west direction, and up to about 195 feet in the north-south direction. The property includes about 55 feet of frontage along West Mercer Way. Single-family homes are located to the north and east of the property, and undeveloped land and two single-family residences are located to the south of the property.

The site is currently undeveloped, and cannot be accessed by vehicle at the present time due to a lack of driveway and the presence of a drainage ditch between the property and West Mercer Way. The majority of the site is forested with moderately mature to mature native evergreen and deciduous trees, and includes an understory of ferns, salal and other native plant species.

The topography of the site slopes down moderately to gently from the east to west, with the exception of eastern portions of the site that slope down at grades of 40% or slightly more. Based on our review of the topographic survey, prepared by PACE Engineering, site grades along the eastern property line range from about 240 to 250 feet (NAVD88) and site grades along the western property line are around 175 feet.

Plate 1 on the following page depicts current site conditions.



*Plate 1. Looking northeast near the middle of the site at the general location of the proposed residence.*

We understand that the proposed project includes the construction of a three-level single-family residence with a daylight basement in the northeastern portion of the subject property. Figure 2 depicts the approximate location of the proposed house in relation to the property boundaries and existing site features. The basement finished floor elevation will be around 207.5 feet, and the main floor will have a finished floor elevation of about 218 feet (NAVD88). Due to the sloping topography of the site, and the depressed basement floor elevation, which we understand was required to match the required driveway grade, the basement and first floor will be cut into the slope, and will daylight to the west. The excavation necessary to construct the basement will extend up to about 20 feet below existing grades. Based on our discussions with the project team, we understand that the basement excavation will be supported by a combination of open cut slopes and soldier pile walls.

### **3.0 SUBSURFACE EXPLORATIONS**

A subsurface exploration program was completed on May 10 and 11, 2017. The subsurface exploration program included four test borings (PG-1 through PG-4) that were advanced on the subject site. In addition, two borings, PG-5 and PG-6, were advanced on the adjacent property to the east for a different geotechnical study, but were also utilized for this study to further understand subsurface conditions in the project area. The approximate test boring locations were measured from existing site features and are indicated on the attached Site and Exploration Plan (Figure 2). The borings were drilled to depths of about 9 to 17 feet below surface grades using a portable acker drill rig owned and operated by CN Drilling, of Seattle, Washington. The drill rig was equipped with a 4-inch outside diameter hollow stem auger, and soil samples were obtained from the borings at 2½ and 5-foot intervals in general accordance with Standard Penetration Test (SPT) sampling methods (ASTM test method D-1586) in which the samples are obtained using a 2-inch outside diameter split-spoon sampler. The sampler was driven into the soil a distance of 18 inches using a 140-pound weight falling a distance of 30 inches. The number of blows required for each 6-inch increment of sampler penetration was recorded. The number of blows required to achieve the last 12 inches of sample penetration is defined as the SPT N-value. The N-value provides an empirical measure of the relative density of cohesionless soil, or the relative consistency of fine-grained soils.

An engineer from PanGEO was present during the field explorations to observe the test borings, obtain representative samples, and to describe and document the soils encountered in the explorations. The completed borings were backfilled with bentonite chips.

The soil samples retrieved from the borings were described using the system outlined on Figure A-1 of Appendix A and the summary boring logs are included as Figures A-2 through A-7.

### **4.0 SUBSURFACE CONDITIONS**

#### **4.1 SITE GEOLOGY**

The Geologic Map of Mercer Island (Troost and Wisher, 2006) mapped the surficial geologic units on the eastern portion of the subject site as Vashon advance outwash deposits (map unit Q<sub>va</sub>) and Lawton Clay (map unit Q<sub>vlc</sub>) was mapped over the western portion of the site. Approximately one block east of the project site, the surficial geology is mapped as Vashon glacial till (map unit Q<sub>vt</sub>).

Advance outwash deposits ( $Q_{va}$ ) are described by Troost, et al. as dense to very dense, well sorted deposits of sand and gravel, with occasional silt lenses. Lawton clay ( $Q_{vlc}$ ) typically consists of very stiff to hard laminated to massive silty clay and clayey silt. Vashon glacial till ( $Q_{vt}$ ) consists of a very dense, heterogeneous mixture of sand, silt and gravel.

## 4.2 SOIL CONDITIONS

The subsurface explorations at the site generally encountered a sequence of forest duff over alluvium, glacial till and advance outwash deposits. The glacial till and advanced outwash deposits appeared to be consistent with the mapped geology described above.

The soils encountered at each of the subsurface exploration locations are described in the boring logs presented in Appendix A of this report. The attached Figure 3 presents a generalized subsurface profile across the site (Section A-A') based on our interpretation of the subsurface conditions encountered in the explorations.

A summary of the generalized soil units encountered in our test borings are presented below.

***Forest Duff:*** A surficial layer of organic rich soil was encountered in all borings advanced at the site (PG-1 through PG-4). This layer was interpreted to be forest duff, and was found to be very loose, consist primarily of silty sand with prevalent organics, and varied in thickness from about 6 inches to 12 inches. One exception was at boring PG-1, where organic rich soil was encountered up to 3 feet below the ground surface.

***Alluvium:*** Below the forest duff in all borings except PG-1, a soil unit consisting of soft to stiff sandy silt with some gravel, and loose sand with gravel, was encountered to depths ranging from 2 to 6 feet below the existing ground surface. We interpreted this soil unit to be alluvium, likely associated with the seasonal stream south of the property.

***Glacial Till:*** Underlying the forest duff and alluvium, the test borings advanced within the upper, eastern portion of the site (PG-1 and PG-2), encountered very dense silty sand with some gravel, that we interpreted to be glacial till. The glacial till was encountered to the termination depth of the explorations.

***Advance Outwash:*** Underlying the forest duff and alluvium within the western portion of the site, test borings PG-3 and PG-4 encountered generally medium

dense to dense, fine to medium sand with trace to some gravel and silt. We interpreted this dense sand unit to be the mapped advance outwash deposit. We anticipate that the dense advance outwash deposit underlies the glacial till encountered within the eastern portion of the site as well, and was encountered in test boring PG-6, advanced east of the subject site.

#### **4.3 GROUNDWATER CONDITIONS**

At the time of our subsurface investigations (May, 2017), groundwater was not encountered in test borings PG-1 through PG-3. In test boring PG-4, however, which was located within the western, lower portion of the site near West Mercer Way, we observed water at an elevation of approximately 171 feet (NAVD88). Based on the observed soil conditions in all explorations, we anticipate that groundwater becomes perched on the underlying till layer during certain times of the year. Additionally, sporadic zones of perched water are likely to occur within sandy and gravelly layers of the native till deposit. As such, some groundwater seepage due to perched water may occur within the depth of the proposed excavation. Groundwater levels will fluctuate depending on the season and precipitation. In general, groundwater levels are higher during late winter and spring.

### **5.0 GEOLOGIC HAZARDS ASSESSMENT**

#### **5.1 POTENTIAL LANDSLIDE HAZARDS**

The subject site is mapped within a potential landslide hazard area according to the City of Mercer Island's Geologic Hazards Map. The map indicates that slopes of 15% or more and slopes between 40-79% are present at the site. The map does not indicate that landslide or mass wasting deposits exist at the site, nor does the map indicate the presence of a landslide scarp. According to the map, the site does not contain a previously documented landslide location.

A site reconnaissance of the subject property was conducted on May 10, 2017. During our site reconnaissance, we did not observe any apparent evidence of slope instability or ground movement at the site. Based on our field observations, the general topography of the site and vicinity, and the results of our subsurface explorations, in our opinion the subject site is globally stable in its current configuration. Furthermore, it is our opinion that the proposed development as currently planned is feasible from a geotechnical engineering standpoint, and in our opinion will not adversely affect the overall stability of

the site or adjacent properties, provided the recommendations outlined herein are followed and the proposed development is properly design and constructed. Our recommendations include the use of a soldier pile wall to provide temporary support for the proposed basement excavation.

## **5.2 SEISMIC HAZARDS**

Based on our review of the City of Mercer Island's Geologic Hazards Maps, the project site is not mapped as a seismic hazard area. The City of Mercer Island Code defines seismic hazard areas as those areas subject to risk of damage as a result of earthquake-induced ground shaking, slope failure, soil liquefaction or surface faulting. Based on the dense to very dense glacial soils underlying the proposed building site, in our opinion, the potential for soil liquefaction during an IBC-code level earthquake is considered very low. It is also our opinion that the potential for seismic-induced landsliding is low at the site due to the dense to very dense underlying soils and lack of steep slopes greater than 80%. Therefore, we concur with the Geologic Hazard Map, and in our opinion special design considerations associated with soil liquefaction and seismic-induced landsliding are not necessary for this project.

## **5.3 EROSION HAZARDS**

The subject site is mapped within a potential erosion hazard area according to the City of Mercer Island's Geologic Hazards Map. Based on soil conditions encountered in the borings, the near-surface site soils are likely to exhibit moderate erosion potential. In our opinion, the erosion hazards at the site can be effectively mitigated with the best management practice during construction and with properly designed and implemented landscaping for permanent erosion control. During construction, the temporary erosion hazard can be effectively managed with an appropriate erosion and sediment control plan, including but not limited to installing silt fence at the construction perimeter, limiting removal of vegetation to the construction area, placing gravel or hay bales at the disturbed/traffic areas, covering stockpile soil or cut slopes with plastic sheets, constructing a temporary drainage pond to control surface runoff and sediment trap, placing quarry spalls at the construction entrance, etc. Permanent erosion control measures should include establishing vegetation, landscape plants, and hardscape established at the end of project, and reducing surface runoff to the minimum extent possible.

## 6.0 GEOTECHNICAL RECOMMENDATIONS

### 6.1 SEISMIC DESIGN PARAMETERS

The 2015 International Building Code (IBC) seismic design section provides a basis for seismic design of structures. Table 1 below provides seismic design parameters for the site that are in conformance with the 2015 IBC, which specifies a design earthquake having a 2% probability of occurrence in 50 years (return interval of 2,475 years), and the 2008 USGS seismic hazard maps.

**Table 1 – Seismic Design Parameters**

Site Class	Spectral Acceleration at 0.2 sec. [g]	Spectral Acceleration at 1.0 sec. [g]	Site Coefficients		Design Spectral Response Parameters	
	$S_s$	$S_1$	$F_a$	$F_v$	$S_{DS}$	$S_{D1}$
D	1.44	0.55	1.0	1.5	0.96	0.55

The spectral response accelerations were obtained from the USGS Earthquake Hazards Program website (2008 data) for the project latitude and longitude.

**Liquefaction Potential:** Liquefaction is a process that can occur when soils lose shear strength for short periods of time during a seismic event. Ground shaking of sufficient strength and duration results in the loss of grain-to-grain contact and an increase in pore water pressure, causing the soil to behave as a fluid. Soils with a potential for liquefaction are typically cohesionless, predominately silt and sand sized, loose to medium dense, and must be saturated. Because the proposed building site is not underlain by saturated silt or loose to medium dense sand, in our opinion the liquefaction potential below the proposed structure is low, and design considerations related to soil liquefaction are not necessary for this project.

### 6.2 SPREAD FOOTINGS

Based on our understanding of the subsurface conditions at the site, in our opinion the proposed residence may be supported by conventional spread and strip footings. Footings should be founded on the medium dense to dense sandy soils anticipated to be present at the proposed foundation elevation.



### ***6.2.1 Allowable Bearing Pressure***

We recommend a maximum allowable soil bearing pressure of 3,000 pounds per square foot (psf) be used to size the footings. The recommended allowable bearing pressure is for dead plus live loads. For allowable stress design, the recommended bearing pressure may be increased by one-third for transient loading, such as wind or seismic forces. Continuous and individual spread footings should have minimum widths of 18 and 24 inches, respectively.

Total and differential settlements are anticipated to be within tolerable limits for footings designed and constructed as discussed above. Footing settlement under static loading conditions is estimated to be less than about ¾-inch. We anticipate differential settlement across the footprint of the house should be less than about ½-inch. Most settlement will occur during construction as loads are applied.

### ***6.2.2 Lateral Resistance***

Lateral loads on the structure may be resisted by passive earth pressure developed against the embedded portion of the foundation system and by frictional resistance between the bottom of the foundation and the supporting subgrade soils. Footings bearing on the medium dense to very dense native soils, may be designed using a frictional coefficient of 0.35 to evaluate sliding resistance developed between the concrete and the subgrade soil. Passive soil resistance may be calculated using an equivalent fluid weight of 300 pcf, assuming foundations are backfilled with structural fill. The above values include a factor of safety of 1.5. Unless covered by pavements or slabs, the passive resistance in the upper 12 inches of soil should be neglected.

### ***6.2.3 Perimeter Footing Drains***

Footing drains should be installed around the perimeter of the residence, at or just below the invert of the footings. Under no circumstances should roof downspout drain lines be connected to the footing drain systems. Roof downspouts must be separately tightlined to appropriate discharge locations. Cleanouts should be installed at strategic locations to allow for periodic maintenance of the footing drain and downspout tightline systems.

#### **6.2.4 Footing Subgrade Preparation**

Footing subgrades should be in a dense and stable condition prior to setting forms and placing reinforcing steel. Any loose or softened soil should be removed from the footing excavations. The adequacy of the footing subgrade soils should be verified by a representative of PanGEO, prior to placing forms or rebar.

If loose or disturbed soil is encountered at the footing elevation, the footing may be lowered to bear on the undisturbed soils, or the unsuitable soils should be removed and replaced with properly compacted structural fill, or lean-mix concrete.

#### **6.3 FLOORS SLABS**

We anticipate that competent, native soil will be encountered at the slab level. Structural fill placed below the slab should be properly compacted in accordance with the structural fill recommendations presented in this report. The exposed subgrade should be compacted to a firm condition prior to placing the backfill or capillary break layer.

Interior concrete slab-on-grade floors should be underlain by a capillary break consisting of at least of 4 inches of pea gravel or compacted 5/8-inch, clean crushed rock (less than 3 percent fines). The capillary break material should meet the gradational requirements provided in Table 2, below.

**Table 2 – Capillary Break Gradation**

Sieve Size	Percent Passing
¾-inch	100
No. 4	0 – 10
No. 100	0 – 5
No. 200	0 – 3

The capillary break should be placed on the subgrade that has been compacted to a dense and unyielding condition.

We recommend that a 10-mil polyethylene vapor barrier should also be placed directly below the slab. Construction joints should be incorporated into the floor slab to control cracking.

## **6.4 BASEMENT WALL DESIGN PARAMETERS**

Below-grade walls should be properly designed to resist the lateral earth pressures exerted by the soils behind the wall. Proper drainage provisions should also be provided behind the walls to intercept and remove groundwater from behind the wall. Our geotechnical recommendations for the design and construction of the below-grade walls are presented below.

### ***6.4.1 Lateral Earth Pressures***

A temporary soldier pile wall will be used for shoring around the majority of the basement perimeter. The below grade portions of basement walls cast against the shoring walls may be designed for an earth pressure based upon an equivalent fluid weight of 40 pcf, assuming a maximum backslope of 2H:1V. For a basement wall that is constructed in an open cut and then backfilled, which might be used along the western portion of the south wall, the wall may be designed for an earth pressure based upon an equivalent fluid weight of 35pcf for a wall that is allowed to yield, and 50 pcf for a wall that is restrained (assuming level backslope). The recommended lateral pressures assume that the backfill behind the wall consists of a free draining and properly compacted fill with adequate drainage provisions.

A uniform pressure of 7H psf should be added to all basement walls to reflect the increase loading for seismic conditions, where H corresponds to the buried depth of the wall.

If surcharge loads or building foundations will be located within a horizontal distance equal to the height of the backfilled wall, lateral earth pressures will need to be increased based upon the type and magnitude of surcharge.

### ***6.4.2 Lateral Resistance***

Lateral forces from wind or seismic loading may be resisted by the combination of passive earth pressures acting against the embedded portions of the foundations and by friction acting on the base of the foundations. Passive resistance values may be determined using an equivalent fluid weight of 300 pounds per cubic foot (pcf). This value includes a factor of safety of at least 1.5 assuming that a properly compacted structural fill will be placed adjacent to the sides of the footings. A coefficient friction of 0.35 may be used to determine the frictional resistance at the base of the footings. This coefficient includes a factor of safety of approximate 1.5.

#### **6.4.3 Wall Backfill**

Based on the results of our test borings, the on-site soils consist of sandy silt, silty sand, and sand. The silty soils would not be suitable to be re-used as wall backfill, but the clean sand (native advance outwash) may be suitable for re-use, if the silt content is low, and the soil can be adequately compacted. For budgeting purpose, we recommend that wall backfill consist of imported free draining granular soils such as Seattle Mineral Aggregate Type 17 or Gravel Borrow as defined in Section 9-03.14(1) of the WSDOT *Standard Specifications for Road, Bridge, and Municipal Construction* (WSDOT, 2016) In areas where the space is limited between the wall and the face of excavation, clean crushed 5/8-inch rock may be used as backfill without compaction.

Wall backfill should be moisture conditioned to within about 3 percent of optimum moisture content, placed in loose, horizontal lifts less than 8 inches in thickness, and systematically compacted to a dense and relatively unyielding condition and to at least 95 percent of the maximum dry density, as determined using test method ASTM D 1557. Within 5 feet of the wall, the backfill should be compacted to 90 percent of the maximum dry density.

#### **6.4.4 Wall Drainage & Damp Proofing**

Provisions for permanent control of subsurface water should be incorporated into the design and construction of the below-grade walls. As a minimum, 4-inch diameter perforated drainpipes should be installed behind and at the base of the wall footings, embedded in 12 to 18 inches of pea or washed gravel. The gravel should be wrapped in a geotextile filter fabric to prevent the migration of fines into the drain system. The drainpipe should be graded to direct water to a suitable outlet.

Where the below-grade wall will be constructed against a soldier pile wall, we recommend that prefabricated drainage mats, such as Mirafi 6000 or equivalent, be installed behind the walls (full face coverage) and the collected water should be directed through weep holes inside the building beneath the floor slab and tight-lined to an appropriate outlet.

Please note that waterproofing considerations are beyond our scope of work. We recommend that a building envelope specialist be consulted to determine appropriate damp-proofing or water-proofing measures.

## **6.5 DRIVEWAY PAVEMENT**

Based on our review of the preliminary grading plans, a driveway will be constructed from West Mercer Way to the proposed residence. We understand that the driveway grade will generally be several feet below the existing ground surface. Areas to receive fill or pavement should be stripped and cleared of vegetation, organic matter, and other deleterious material, if not removed during grading. Based on our test borings in the area, we anticipate that loose to medium dense soils may be encountered below the driveway alignment. Following the stripping operation and excavations necessary to achieve construction subgrade elevations, the ground surface where structural fill or pavements are to be placed should be compacted to a dense condition with a large roller. Any loose or soft areas that cannot be adequately compacted should be over-excavated to a maximum of 2 feet and replaced with properly compacted granular structural fill. A geotextile fabric may need to be placed below the structural fill if soft or wet subgrade conditions are present.

If concrete pavement is used, which would likely be more durable considering the steep driveway grade, we recommend a minimum 4-inch thick concrete slab over overlying a 6-inch thick layer of 1¼-inch crushed surfacing base course (CSBC). Both the subgrade/structural fill and crushed rock base should be compacted to a minimum of 95% of the materials maximum dry density (Modified Proctor ASTM D-1557).

To increase the performance of the driveway, the slab could be thickened, and/or the crushed rock layer increased. The pavement may also be constructed with increased steel reinforcing, to resist cracking, and control joints should be incorporated to control potential cracking.

## **6.6 DRIVEWAY RETAINING WALLS**

We understand that low retaining walls may be needed along the proposed driveway alignment to retain cuts or fills. Based on our review of the preliminary driveway alignment, we estimate that retaining walls will be less than about 4 feet tall. Although a number of wall types are considered technically feasible for this project, based on our experience, it is our opinion that the most cost-effective wall type will be a gravity wall.

### **6.6.1 Gravity Wall**

The principal advantage of a gravity wall is the ease and speed of construction, and the low construction cost. If a gravity wall will be used for this project, we recommend that either a concrete block wall or a rock-filled gabion wall be used.

Precast concrete blocks of various sizes may be used for this project. One commonly used product is Ultra Block ([www.ultrablock.com](http://www.ultrablock.com)), which has a typical dimension of 2½ feet by 2½ feet by 5 feet. Blocks made of returned concrete, and have dimensions of 2 feet by 2 feet by 6 feet (i.e. ecology blocks) should not be used. Concrete blocks can be made with various finishes or texture to provide the desired aesthetics. All concrete block walls should be battered no steeper than 6V:1H.

Alternatively, small concrete blocks such as those manufactured by Keystone ([www.keystonewalls.com](http://www.keystonewalls.com)) or other suppliers may also be used provided that there is no traffic surcharge near the top of the wall (i.e. edge pavement should be located at least 4 feet from the wall face). Alternatively, if the wall backfill is reinforced with geogrid, the wall could be specifically designed to resist the surcharge load. Although we don't expect wall heights to be greater than about 4 feet, because these blocks are typically quite narrow, it may be necessary to double up the blocks if the wall exceeds about 4 feet of exposed height, depending on the individual block size. We recommend that, if small blocks will be used, the walls be designed by the supplier using the geotechnical design parameters outlined below.

Gabion walls should be constructed in general accordance with WSDOT Standard Plan Sheet D-6, and Section 8-24.3(3) Gabion Cribbing of the 2016 *WSDOT Standard Specifications*. Each gabion basket should be placed horizontally and with a minimum of 6 inches of setback from the basket below, hence creating an average wall face inclination of no steeper than 6V:1H. Dimensions of gabion baskets may vary depending on the suppliers.

**Minimum Width** – In general, as a minimum, all gabion baskets and concrete blocks should have a minimum width equal to the greater of 2 feet or one-third the wall height.

**Minimum Embedment & Subgrade Improvement** - Gravity walls should have a minimum of one foot of embedment. All walls should be founded on competent native soils or properly compacted fill. We anticipate that loose soils may be present along the driveway alignment within 5 feet of surface grades. To provide a firm base for the retaining walls, we recommend a 12-inch thick layer of 2- to 4-inch quarry spalls be placed below the wall

alignment. A geotextile fabric should be placed over the subgrade prior to rock placement. If needed, a 6-inch layer of granular structural fill such as crushed rock may be placed as a leveling course before placing the base course of blocks.

**Geotechnical Design Parameters** – We recommend that the following geotechnical parameters be used for design of gravity walls:

Active earth pressure:	35 pcf
Allowable Passive Pressure:	300 pcf
Allowable Friction Coefficient:	0.40
Allowable Bearing Capacity:	2500 psf

### **6.6.2 Wall Backfill and Drainage Considerations**

Where backfill is needed behind gravity walls, free draining granular material is recommended. A drainage system should be provided behind the base of all walls greater than 2 feet in height to prevent buildup of hydrostatic pressures. As a minimum, the drain should consist of 4-inch diameter perforated PVC pipe, encased in washed drain rock wrapped in filter fabric. The footing drain should discharge to a storm drain or appropriate outlet.

### **6.7 ON-SITE INFILTRATION CONSIDERATIONS**

Based on our review of the City of Mercer Island Low Impact Development (LID) infiltration feasibility map, the project site is located in an area where infiltrating LID is not permitted.

## **7.0 CONSTRUCTION CONSIDERATIONS**

### **7.1 TEMPORARY UNSUPPORTED EXCAVATIONS**

Temporary excavations should be constructed in accordance with Part N of WAC (Washington Administrative Code) 296-155. The contractor is responsible for maintaining safe excavation slopes and/or shoring. It is our opinion temporary excavations at the site parallel to the overall slope angle may be cut at a maximum 2H:1V inclination, to remain stable, and reduce the potential of destabilizing the site. Temporary excavations perpendicular to the overall slope angle (i.e. excavations that will not be surcharged by a backslope), may be cut at a maximum of 1H:1V.

Temporary excavations should be evaluated in the field during construction based on actual observed soil conditions. If seepage is encountered, excavation slope inclinations may need to be reduced. During wet weather, the cut slopes may need to be flattened to reduce potential erosion and should be covered with plastic sheeting.

## **7.2 TEMPORARY EXCAVATION SHORING**

We understand that 2H:1V slopes will be cut adjacent to the proposed house footprint to reduce the height of the basement walls. As such, excavations ranging up to about 10 feet deep may be needed to construct the house foundation and basement walls, which we recommend be supported by a cantilevered soldier pile wall. We believe that a soldier pile wall with timber lagging represents the most appropriate method to support the excavation and maintain stability of the slope.

### ***7.2.1 Soldier Pile Wall***

A soldier pile wall consists of vertical steel beams, typically spaced from 6 to 8 feet apart along the proposed excavation wall, spanned by timber lagging. Prior to the start of excavation, the steel beams are installed into holes drilled to a design depth and then backfilled with lean mix or structural concrete. As the excavation proceeds downward and the steel piles are subsequently exposed, timber lagging is installed between the piles to support the soils between piles.

### ***7.2.2 Design Lateral Pressures***

The attached Figure 4 should be used to design a cantilevered temporary shoring walls at the site, or a wall with a single level of tiebacks. The design lateral earth pressure considers the back slope surcharge pressure from the existing slope. If tiebacks will be needed for wall stability, or to create a more cost-effective wall design, PanGEO will provide additional recommendations for tieback design upon request.

Above the bottom of excavation, the recommended active earth and surcharge pressures should be applied over the full width of pile spacing. Below the bottom of excavation, the active pressures should be applied over one pile spacing, and the passive resistance should be applied over two times the pile diameter.

For the soldier pile wall along the eastern building line (Gridline E), we recommend the top 5 feet of passive resistance be ignored to account for the adjacent wall along building line "D".



We also recommend that the lagging be sized using the recommendations depicted on Figure 4.

### ***7.2.3 Permanent Wall Considerations***

We understand that a permanent soldier pile wall will be constructed to the south of the new house to retain soils adjacent to the proposed patio area. The same recommendations apply to permanent walls as temporary walls, except that an additional surcharge pressure due to seismic loading must be included in design, as indicated on Figure 4. In addition, the piles should include corrosion protection, or be over-sized to account for long-term corrosion. Lagging for permanent walls may consist of pressure-treated timber, cast-in-place or pre-cast concrete beams, or steel sheets.

### ***7.2.4 Soldier Pile Installation Considerations***

The drilling of soldier piles is anticipated to encounter several feet of loose silty sand over medium dense to very dense silty sand with gravel (glacial till) underlain by dense sand (advance outwash). Boulders and cobbles are often present in glacial till deposits, and may be encountered during drilling. Caving in the upper loose soils, as well as within wet sandy or gravel layers in the till or outwash may occur during drilling. As a result, the drilling contractor should be prepared to use temporary casings to stabilize the holes.

Groundwater may accumulate at the bottom of drill holes depending on the time of construction. We recommend that the lean concrete or structural concrete backfill be placed with tremie pipes if more than one foot of water is present at the bottom of the holes.

When placing timber lagging, the height of each lift may need to be limited when the wet soils are encountered. The actual allowable vertical cut for timber lagging placement should be determined in the field, based on the actual conditions observed.

## **7.3 GROUNDWATER CONTROL**

Perched groundwater seepage may be encountered within the foundation excavations, and should be anticipated. Groundwater seepage, although expected to be relatively minor, may be controlled by sloping the base of the excavation to a low point and removing the water using a sump and pump.

#### **7.4 MATERIAL REUSE**

The native soils underlying the site are moisture sensitive, particularly the alluvium and glacial till, and will become disturbed and soft when exposed to inclement weather conditions. For planning purposes, we do not recommend reusing the native soils as structural fill. If it is planned to use the native soil in non-structural areas, the excavated soil should be stockpiled and protected with plastic sheeting to prevent it from becoming saturated by precipitation or runoff.

#### **7.5 STRUCTURAL FILL AND COMPACTION**

During dry weather, some native soils that are compactable and non-organic may be suitable as structural fill, except for locations under footings. Some of the native soils contain a high percentage of fines and will degrade if exposed to excessive moisture, and compaction and grading will be difficult or impossible if the moisture content increases above the optimum condition. The native soils may potentially be used as backfill provided grading operations are conducted during dry weather and the contractor can control the moisture content of the soils to near the optimum moisture level for compaction.

If the site soils are exposed to moisture (groundwater, precipitation or surface runoff) and cannot be adequately compacted for use as structural fill, then it may be necessary to import a soil that can be compacted. Fill for use during wet weather should consist of a fairly well graded granular material having a maximum grain size of three inches and no more than 5 percent fines passing the US No. 200 sieve based on the minus 3/4-inch fraction. A contingency in the earthwork budget should be included for this possibility.

Structural fill should be placed in 8- to 12-inch thick loose lifts and compacted to at least 95 percent maximum dry density, per ASTM D-1557 (Modified Proctor). In non-structural areas, the recommended compaction level may be reduced to 90 percent. Heavy compaction equipment should operate directly over utilities until a minimum of 2 feet of backfill has been placed.

The procedure to achieve proper density of a compacted fill depends on the size and type of compaction equipment, the number of passes, thickness of the lifts being compacted, and certain soil properties. If the excavation to be backfilled is constricted and limits the use of heavy equipment, smaller equipment can be used, but the lift thickness will need to be reduced to achieve the required relative compaction.

Generally, loosely compacted soils are a result of poor construction technique or improper moisture content. Soils with high fines contents are particularly susceptible to becoming too wet and coarse-grained materials easily become too dry, for proper compaction. Silty or clayey soils with a moisture content too high for adequate compaction should be dried as necessary, or moisture conditioned by mixing with drier materials, or other methods.

The surficial duff layer is not suitable for use as structural fill, nor should it be mixed with materials to be used as structural fill.

## **7.6 WET WEATHER CONSTRUCTION**

General recommendations relative to earthwork performed in wet weather or in wet conditions are presented below. The following procedures are best management practices recommended for use in wet weather construction:

- Earthwork should be performed in small areas to minimize subgrade exposure to wet weather. Excavation or the removal of unsuitable soil should be followed promptly by the placement and compaction of clean structural fill. The size and type of construction equipment used may have to be limited to prevent soil disturbance.
- During wet weather, the allowable fines content of the structural fill should be reduced to no more than 5 percent by weight based on the portion passing the 0.75-inch sieve. The fines should be non-plastic.
- The ground surface within the construction area should be graded to promote run-off of surface water and to prevent the ponding of water.
- Geotextile silt fences should be installed at strategic locations around the site to control erosion and the movement of soil.
- Excavation slopes and soils stockpiled on site should be covered with plastic sheeting.

## **7.7 EROSION CONSIDERATIONS**

Surface runoff can be controlled during construction by careful grading practices. Typically, this includes the construction of shallow, upgrade perimeter ditches or low earthen berms in conjunction with silt fences to collect runoff and prevent water from entering excavations or to prevent runoff from the construction area leaving the immediate

work site. Temporary erosion control may require the use of hay bales on the downhill side of the project to prevent water from leaving the site and potential storm water detention to trap sand and silt before the water is discharged to a suitable outlet. All collected water should be directed under control to a positive and permanent discharge system.

Permanent control of surface water should be incorporated in the final grading design. Adequate surface gradients and drainage systems should be incorporated into the design such that surface runoff is collected and directed away from the structure to a suitable outlet. Potential issues associated with erosion may also be reduced by establishing vegetation within disturbed areas immediately following grading operations.

## **8.0 ADDITIONAL SERVICES**

To confirm that our recommendations are properly incorporated into the design and construction of the proposed structure, PanGEO should be retained to conduct a review of the final project plans and specifications, and to monitor the construction of geotechnical elements. The City of Mercer Island, as part of the permitting process, may also require geotechnical construction inspection services. PanGEO can provide you a cost estimate for construction monitoring services at a later date.

## **9.0 CLOSURE**

We have prepared this report for the Mills Family and the project design team. Recommendations contained in this report are based on a site reconnaissance, a subsurface exploration program, review of pertinent subsurface information, and our understanding of the project. The study was performed using a mutually agreed-upon scope of services.

Variations in soil conditions may exist between the locations of the explorations and the actual conditions underlying the site. The nature and extent of soil variations may not be evident until construction occurs. If any soil conditions are encountered at the site that are different from those described in this report, we should be notified immediately to review the applicability of our recommendations. Additionally, we should also be notified to review the applicability of our recommendations if there are any changes in the project scope.

The scope of our work does not include services related to construction safety precautions. Our recommendations are not intended to direct the contractors' methods, techniques,

sequences or procedures, except as specifically described in our report for consideration in design. Additionally, the scope of our services specifically excludes the assessment of environmental characteristics, particularly those involving hazardous substances. We are not mold consultants nor are our recommendations to be interpreted as being preventative of mold development. A mold specialist should be consulted for all mold-related issues.

This report has been prepared for planning and design purposes for specific application to the proposed project in accordance with the generally accepted standards of local practice at the time this report was written. No warranty, express or implied, is made.

This report may be used only by the client and for the purposes stated, within a reasonable time from its issuance. Land use, site conditions (both off and on-site), or other factors including advances in our understanding of applied science, may change over time and could materially affect our findings. Therefore, this report should not be relied upon after 24 months from its issuance. PanGEO should be notified if the project is delayed by more than 24 months from the date of this report so that we may review the applicability of our conclusions considering the time lapse.

It is the client's responsibility to see that all parties to this project, including the designer, contractor, subcontractors, etc., are made aware of this report in its entirety. The use of information contained in this report for bidding purposes should be done at the contractor's option and risk. Any party other than the client who wishes to use this report shall notify PanGEO of such intended use and for permission to copy this report. Based on the intended use of the report, PanGEO may require that additional work be performed and that an updated report be reissued. Noncompliance with any of these requirements will release PanGEO from any liability resulting from the use this report.

Sincerely,

**PanGEO, Inc.**



Jon C. Rehkopf, P.E.  
Senior Project Geotechnical Engineer

A handwritten signature in black ink, appearing to read "Siew L Tan", written over a horizontal line.

Siew L Tan, P.E.  
Principal Geotechnical Engineer

## 10.0 REFERENCES

International Code Council, 2015, *International Building Code (IBC), 2015*.

Troost, K.G., and Wisher, A. P, 2006. *Geologic Map of Mercer Island, Washington, scale 1:24,000*.

United States Geological Survey, *Earthquake Hazards Program, 2008 Data*, accessed via:  
<http://earthquake.usgs.gov/designmaps/us/application.php>

WSDOT, 2016, *Standard Specifications for Road, Bridge and Municipal Construction, M 41-10*.



Google Terrain Map



Not to Scale



**Proposed Residence**  
**5236 West Mercer Way**  
**Mercer Island, WA**

**VICINITY MAP**

17-143.200

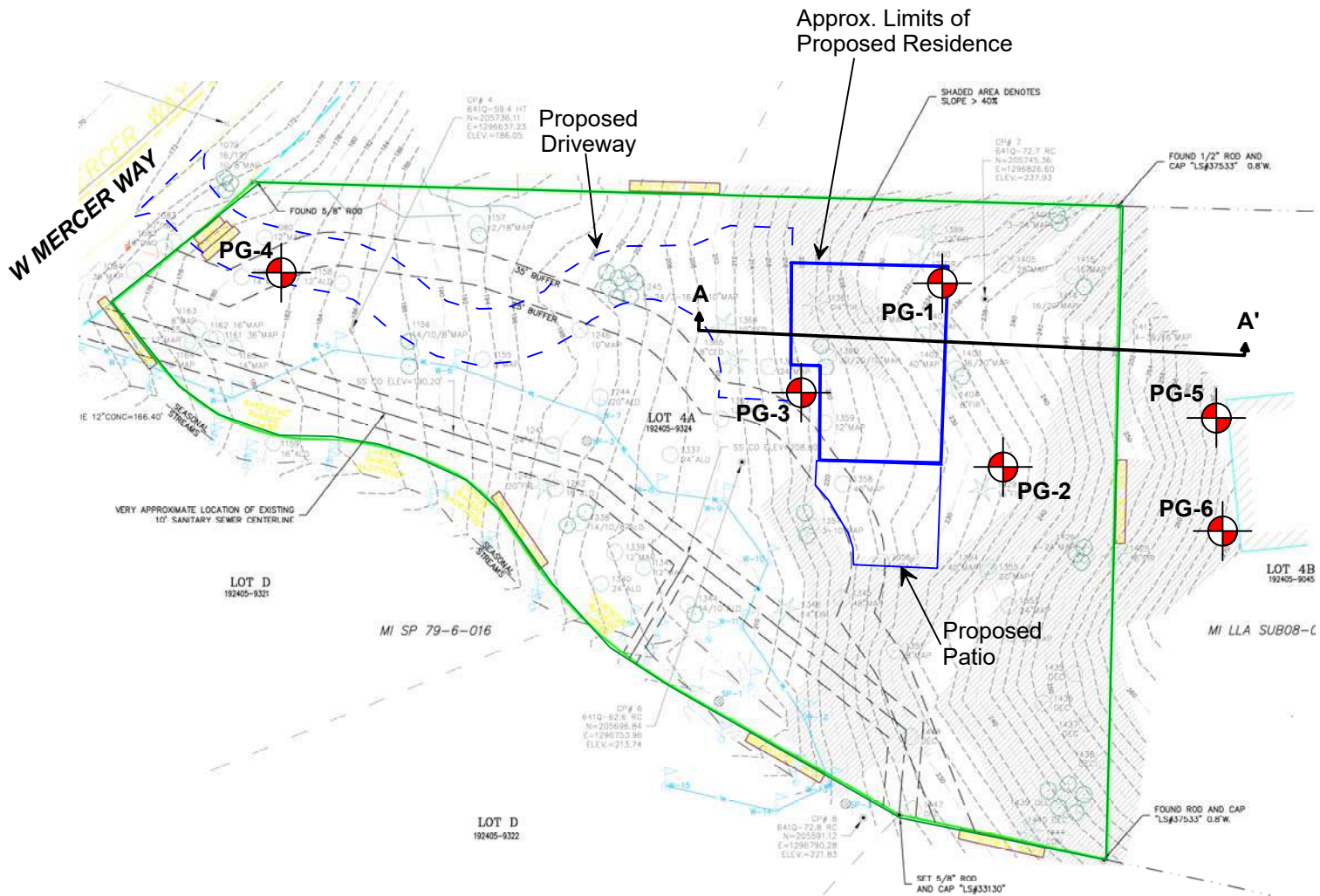

1

  
 Approx. Scale  
 1" = 50'



Note: Site survey prepared by PACE (2017).

Legend:

- 
 Approx. Boring Locations  
 (PanGEO Inc., 2017)
- 
 Subsurface Profile (see Figure 3)



**Proposed Residence**  
**5236 West Mercer Way**  
**Mercer Island, WA**

**SITE AND EXPLORATION PLAN**

Project No. **17-143.200**

Figure No. **2**



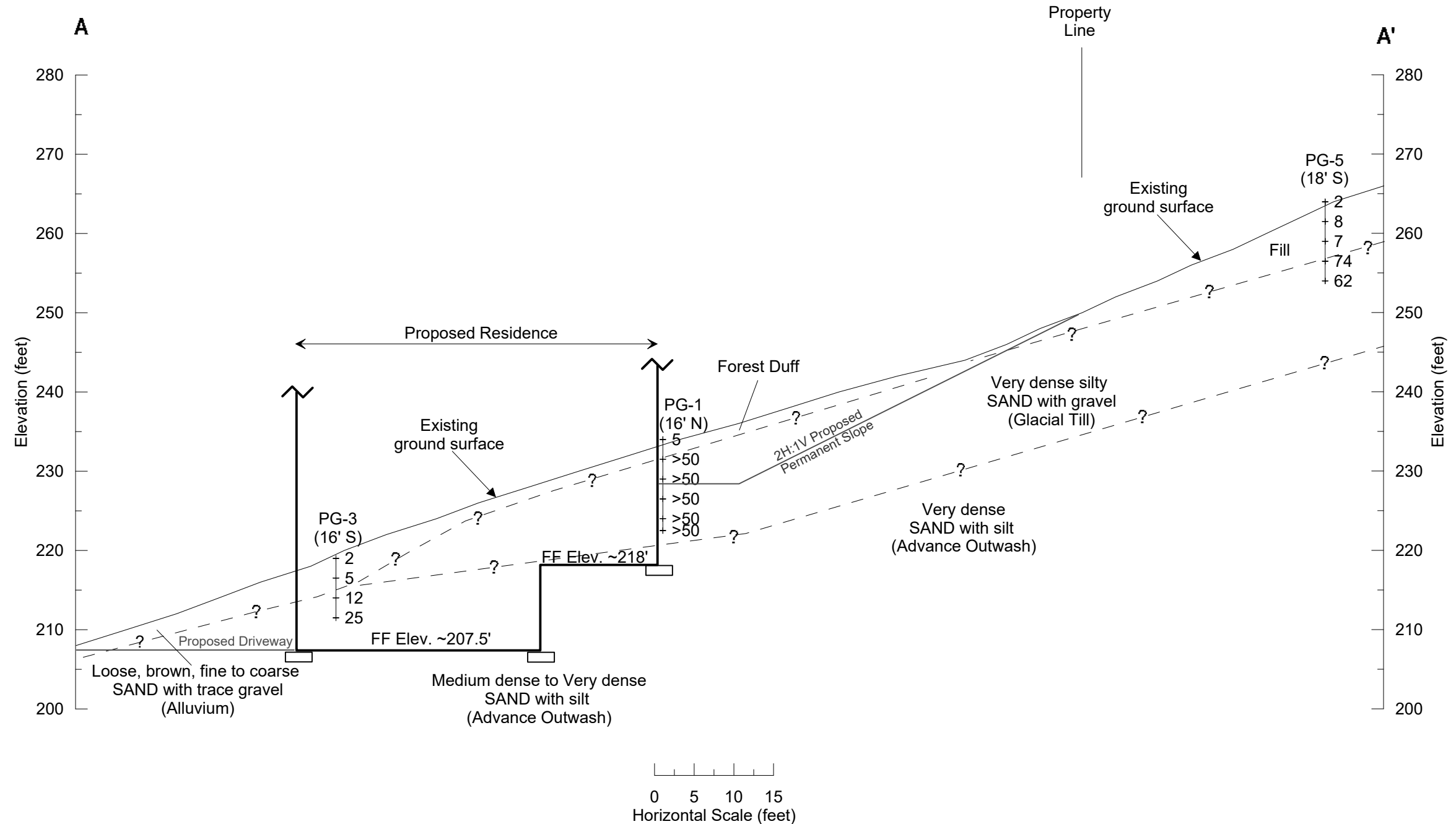

**LEGEND**

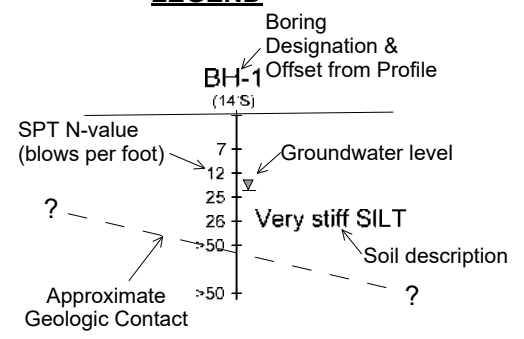

- Notes:
- Existing ground profile based on the topographic survey of 5236 West Mercer Way prepared by PACE Engineers, Inc. (2017).
  - See Figure 2 for location of Section A - A'.
  - See report text for a detailed explanation of the subsurface profile across the site.
  - The generalized soil profile is based on widely-spaced borings. Soil conditions may vary over a small distance, and the actual subsurface conditions may be different from the generalized soil profile depicted in this figure.

	<b>Proposed Residence</b> <b>5236 West Mercer Way</b> <b>Mercer Island, WA</b>	<b>GENERALIZED SUBSURFACE PROFILE</b> <b>SECTION A - A'</b>	
		Project No. <b>17-143</b>	Figure No. <b>3</b>

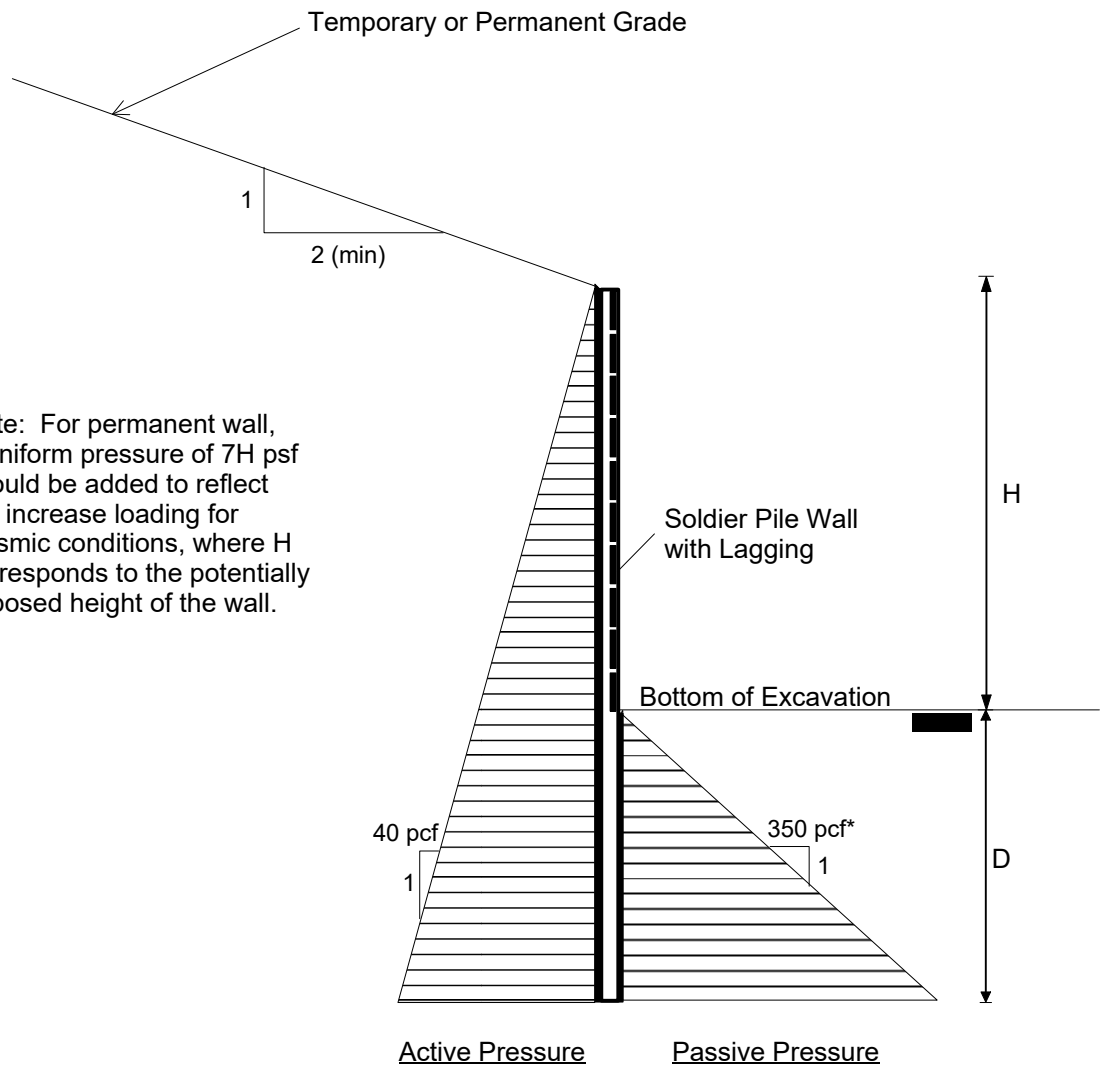

\* For wall along building line "E", ignore top 5 feet of embedment due to wall along building line "D".

Notes:

1. Embedment (D) should be determined by summation of moments at the bottom of the soldier piles. Minimum embedment should be at least 10 feet.
2. A factor of safety of 1.5 has been applied to the recommended passive earth pressure value. No factor of safety has been applied to the recommended active earth pressure values.
3. Active and surcharge pressures should be applied over the full width of the pile spacing above the bottom of excavation, and over one pile diameter below potential slide plane.
4. Passive pressure should be applied to two times the diameter of the soldier piles.
5. Use 50% of the lateral earth pressure for lagging design with soldier piles spaced at 8 feet or less.
6. Refer to report text for additional discussions.

Fig\_4\_EP\_diagram.grf 10/3/17 (14:10) JCR



**Proposed Residence  
5236 West Mercer Way  
Mercer Island, Washington**

**DESIGN LATERAL PRESSURES  
CANTILEVERED SOLDIER PILE WALL**

Project No. **17-143.200**

Figure No. **4**

**APPENDIX A**

**TEST BORING LOGS**

**RELATIVE DENSITY / CONSISTENCY**

SAND / GRAVEL			SILT / CLAY		
Density	SPT N-values	Approx. Relative Density (%)	Consistency	SPT N-values	Approx. Undrained Shear Strength (psf)
Very Loose	<4	<15	Very Soft	<2	<250
Loose	4 to 10	15 - 35	Soft	2 to 4	250 - 500
Med. Dense	10 to 30	35 - 65	Med. Stiff	4 to 8	500 - 1000
Dense	30 to 50	65 - 85	Stiff	8 to 15	1000 - 2000
Very Dense	>50	85 - 100	Very Stiff	15 to 30	2000 - 4000
			Hard	>30	>4000

**UNIFIED SOIL CLASSIFICATION SYSTEM**

MAJOR DIVISIONS		GROUP DESCRIPTIONS	
Gravel 50% or more of the coarse fraction retained on the #4 sieve. Use dual symbols (eg. GP-GM) for 5% to 12% fines.	GRAVEL (<5% fines)		GW: Well-graded GRAVEL
	GRAVEL (>12% fines)		GP: Poorly-graded GRAVEL
Sand 50% or more of the coarse fraction passing the #4 sieve. Use dual symbols (eg. SP-SM) for 5% to 12% fines.	SAND (<5% fines)		GM: Silty GRAVEL
			GC: Clayey GRAVEL
	SAND (>12% fines)		SW: Well-graded SAND
			SP: Poorly-graded SAND
Silt and Clay 50% or more passing #200 sieve	Liquid Limit < 50		SM: Silty SAND
			SC: Clayey SAND
			ML: SILT
	Liquid Limit > 50		CL: Lean CLAY
			OL: Organic SILT or CLAY
			MH: Elastic SILT
Highly Organic Soils			CH: Fat CLAY
			OH: Organic SILT or CLAY
			PT: PEAT

**TEST SYMBOLS**

for In Situ and Laboratory Tests listed in "Other Tests" column.

- ATT Atterberg Limit Test
- Comp Compaction Tests
- Con Consolidation
- DD Dry Density
- DS Direct Shear
- %F Fines Content
- GS Grain Size
- Perm Permeability
- PP Pocket Penetrometer
- R R-value
- SG Specific Gravity
- TV Torvane
- TXC Triaxial Compression
- UCC Unconfined Compression

**SYMBOLS**

Sample/In Situ test types and intervals

- 2-inch OD Split Spoon, SPT (140-lb. hammer, 30" drop)
- 3.25-inch OD Split Spoon (300-lb hammer, 30" drop)
- Non-standard penetration test (see boring log for details)
- Thin wall (Shelby) tube
- Grab
- Rock core
- Vane Shear

- Notes:**
- Soil exploration logs contain material descriptions based on visual observation and field tests using a system modified from the Uniform Soil Classification System (USCS). Where necessary laboratory tests have been conducted (as noted in the "Other Tests" column), unit descriptions may include a classification. Please refer to the discussions in the report text for a more complete description of the subsurface conditions.
  - The graphic symbols given above are not inclusive of all symbols that may appear on the borehole logs. Other symbols may be used where field observations indicated mixed soil constituents or dual constituent materials.

**DESCRIPTIONS OF SOIL STRUCTURES**

<b>Layered:</b> Units of material distinguished by color and/or composition from material units above and below	<b>Fissured:</b> Breaks along defined planes
<b>Laminated:</b> Layers of soil typically 0.05 to 1mm thick, max. 1 cm	<b>Slickensided:</b> Fracture planes that are polished or glossy
<b>Lens:</b> Layer of soil that pinches out laterally	<b>Blocky:</b> Angular soil lumps that resist breakdown
<b>Interlayered:</b> Alternating layers of differing soil material	<b>Disrupted:</b> Soil that is broken and mixed
<b>Pocket:</b> Erratic, discontinuous deposit of limited extent	<b>Scattered:</b> Less than one per foot
<b>Homogeneous:</b> Soil with uniform color and composition throughout	<b>Numerous:</b> More than one per foot
	<b>BCN:</b> Angle between bedding plane and a plane normal to core axis

**COMPONENT DEFINITIONS**

COMPONENT	SIZE / SIEVE RANGE	COMPONENT	SIZE / SIEVE RANGE
Boulder:	> 12 inches	Sand	
Cobbles:	3 to 12 inches	Coarse Sand:	#4 to #10 sieve (4.5 to 2.0 mm)
Gravel	3 to 3/4 inches	Medium Sand:	#10 to #40 sieve (2.0 to 0.42 mm)
		Fine Sand:	#40 to #200 sieve (0.42 to 0.074 mm)
Coarse Gravel:	3 to 3/4 inches	Silt	0.074 to 0.002 mm
Fine Gravel:	3/4 inches to #4 sieve	Clay	<0.002 mm

**MONITORING WELL**

- Groundwater Level at time of drilling (ATD)
- Static Groundwater Level
- Cement / Concrete Seal
- Bentonite grout / seal
- Silica sand backfill
- Slotted tip
- Slough
- Bottom of Boring

**MOISTURE CONTENT**

Dry	Dusty, dry to the touch
Moist	Damp but no visible water
Wet	Visible free water

LOG KEY 08-118 LOG.GPJ\_PANGEO.GDT 11/12/13

Project:	Mills Property, Mercer Island	Surface Elevation:	234.0ft
Job Number:	17-143.200	Top of Casing Elev.:	N/A
Location:	5236 West Mercer Way	Drilling Method:	HSA
Coordinates:	Northing: , Easting:	Sampling Method:	SPT

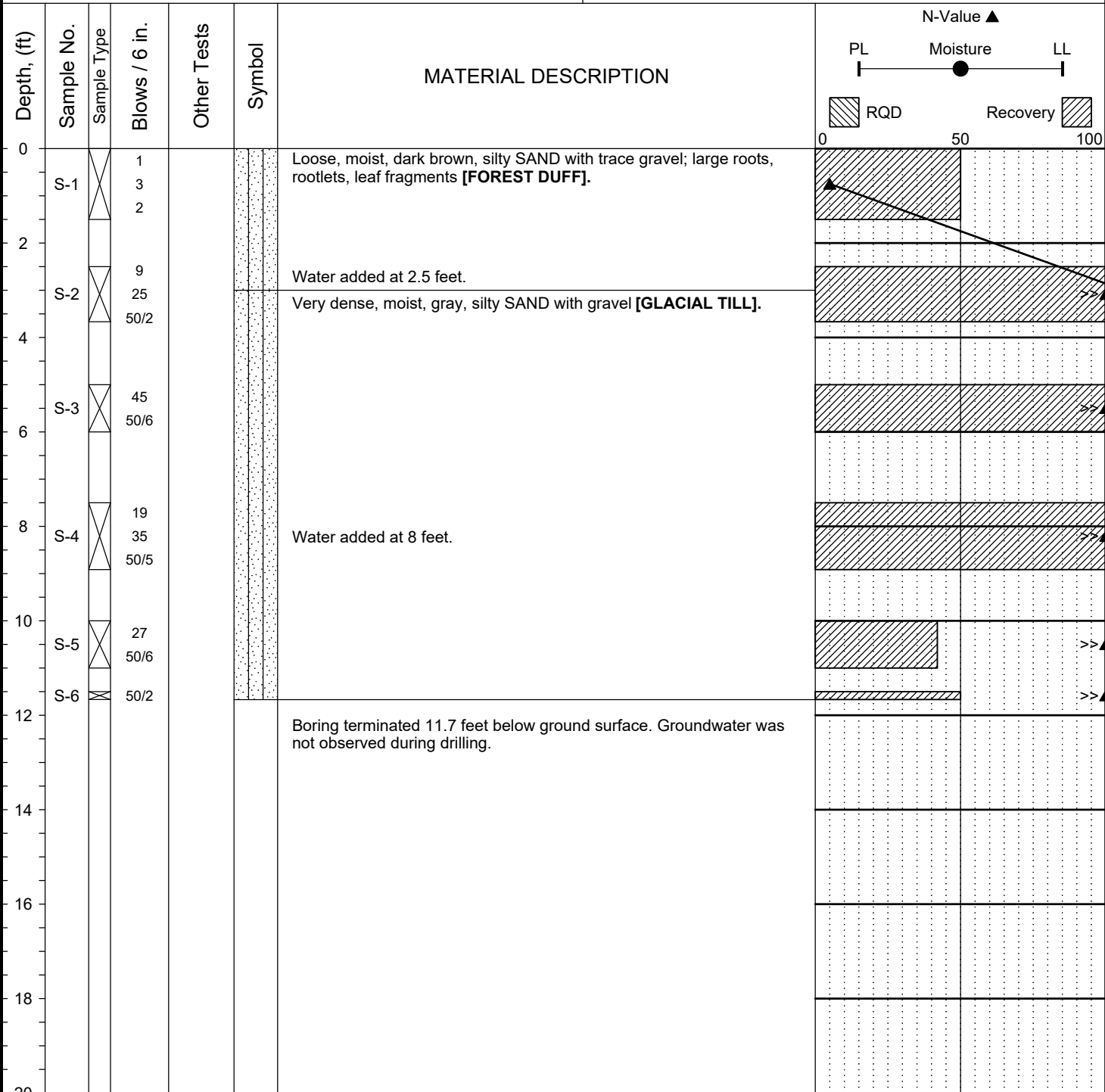

Completion Depth:	13.0ft	Remarks: Boring was drilled with an Acker portable drill rig. Standard Penetration Test (SPT) sampler driven with a 140 lb hammer using a rope and cathead dropping 30 inches per stroke.
Date Borehole Started:	5/10/17	
Date Borehole Completed:	5/10/17	
Logged By:	J. Manke	
Drilling Company:	CN Drilling	

Project:	Mills Property, Mercer Island	Surface Elevation:	233.0ft
Job Number:	17-143.200	Top of Casing Elev.:	N/A
Location:	5236 West Mercer Way	Drilling Method:	HSA
Coordinates:	Northing: , Easting:	Sampling Method:	SPT

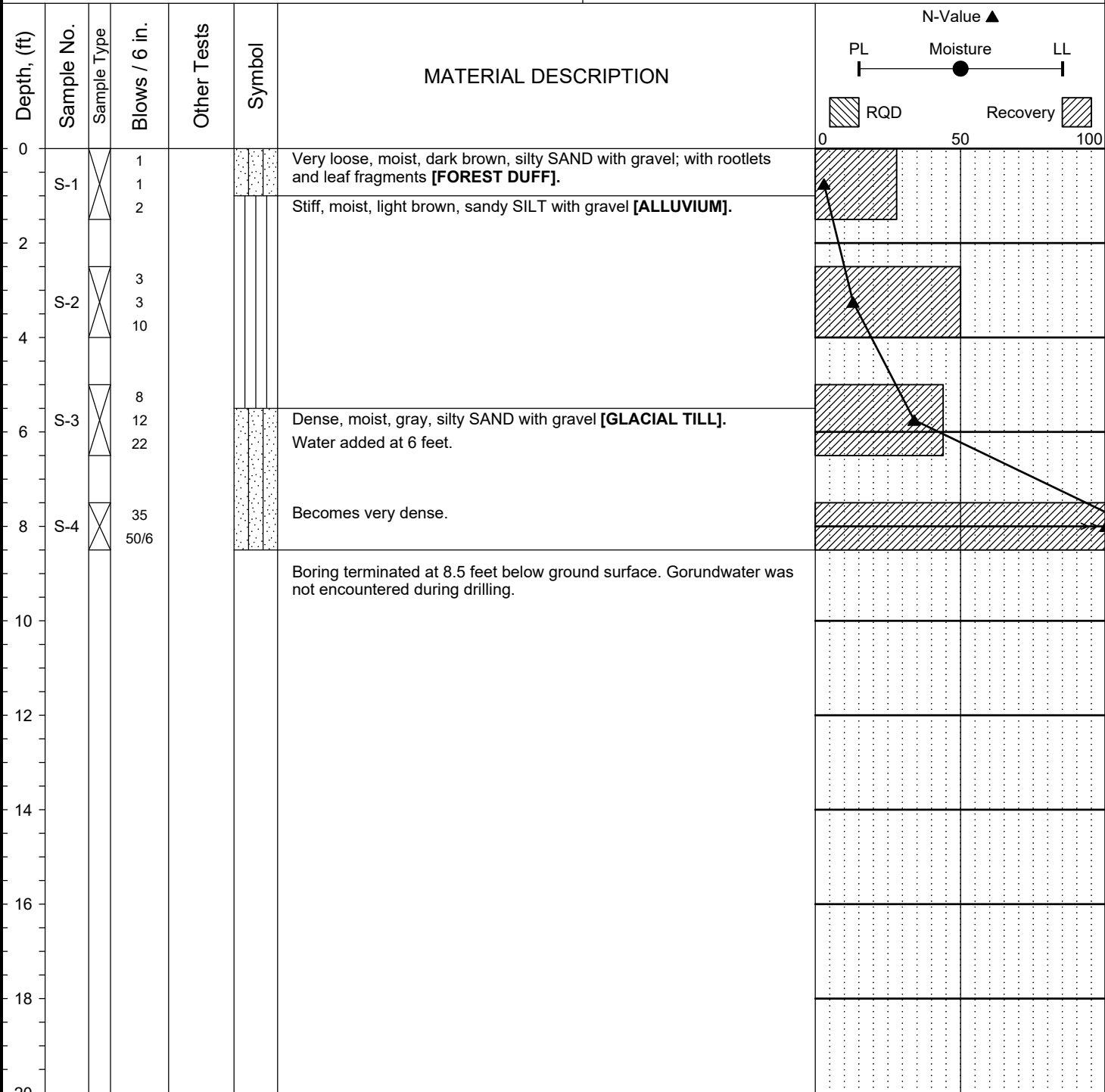

Completion Depth:	8.5ft	Remarks: Boring was drilled with an Acker portable drill rig. Standard Penetration Test (SPT) sampler driven with a 140 lb hammer using a rope and cathead dropping 30 inches per stroke.
Date Borehole Started:	5/10/17	
Date Borehole Completed:	5/10/17	
Logged By:	J. Manke	
Drilling Company:	CN Drilling	

Project:	Mills Property, Mercer Island	Surface Elevation:	218.0ft
Job Number:	17-143.200	Top of Casing Elev.:	N/A
Location:	5236 West Mercer Way	Drilling Method:	HSA
Coordinates:	Northing: , Easting:	Sampling Method:	SPT

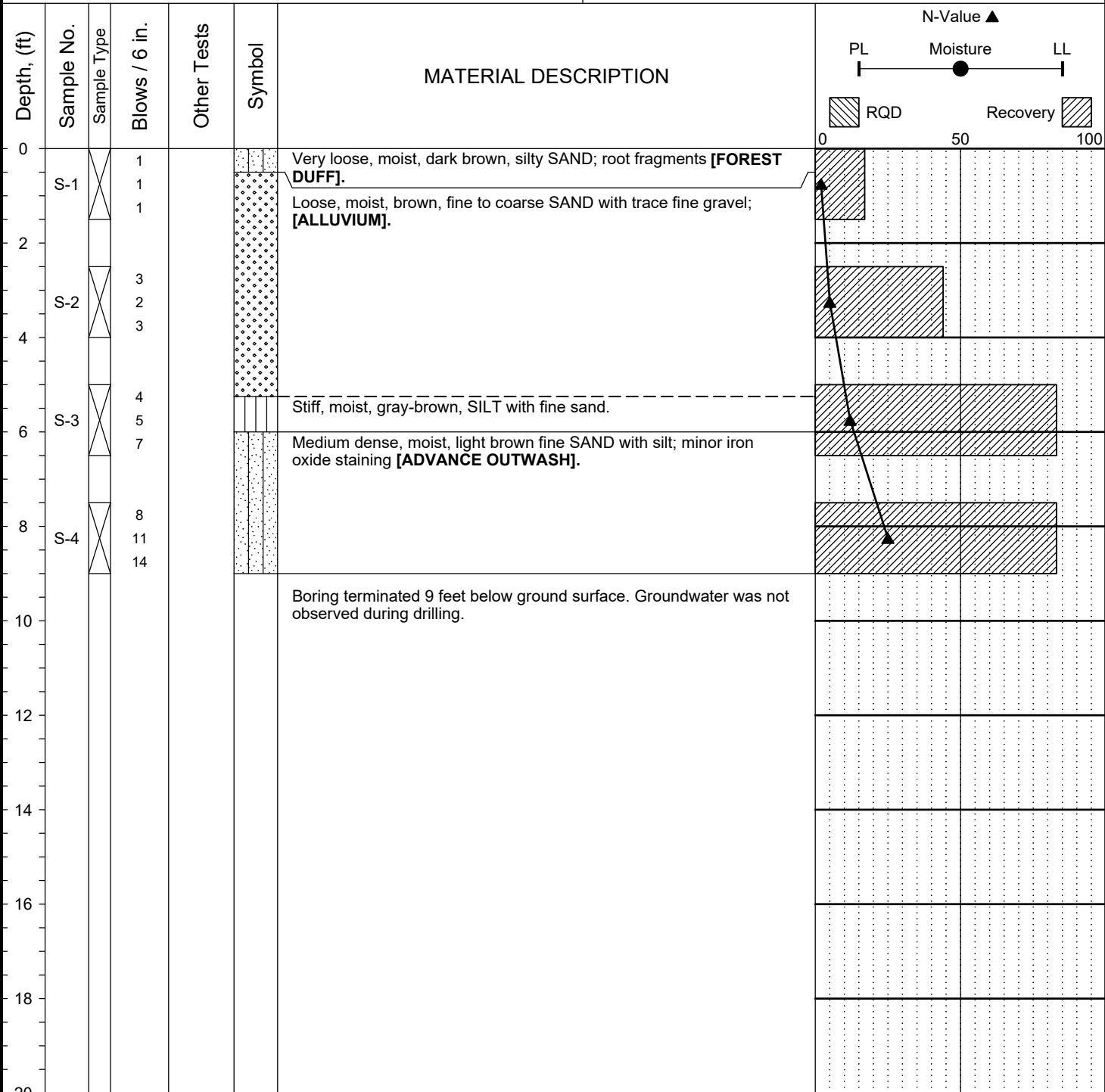

Completion Depth:	9.0ft	Remarks: Boring was drilled with an Acker portable drill rig. Standard Penetration Test (SPT) sampler driven with a 140 lb hammer using a rope and cathead dropping 30 inches per stroke.
Date Borehole Started:	5/10/17	
Date Borehole Completed:	5/10/17	
Logged By:	J. Manke	
Drilling Company:	CN Drilling	

Project:	Mills Property, Mercer Island	Surface Elevation:	181.0ft
Job Number:	17-143.200	Top of Casing Elev.:	N/A
Location:	5236 West Mercer Way	Drilling Method:	HSA
Coordinates:	Northing: , Easting:	Sampling Method:	SPT

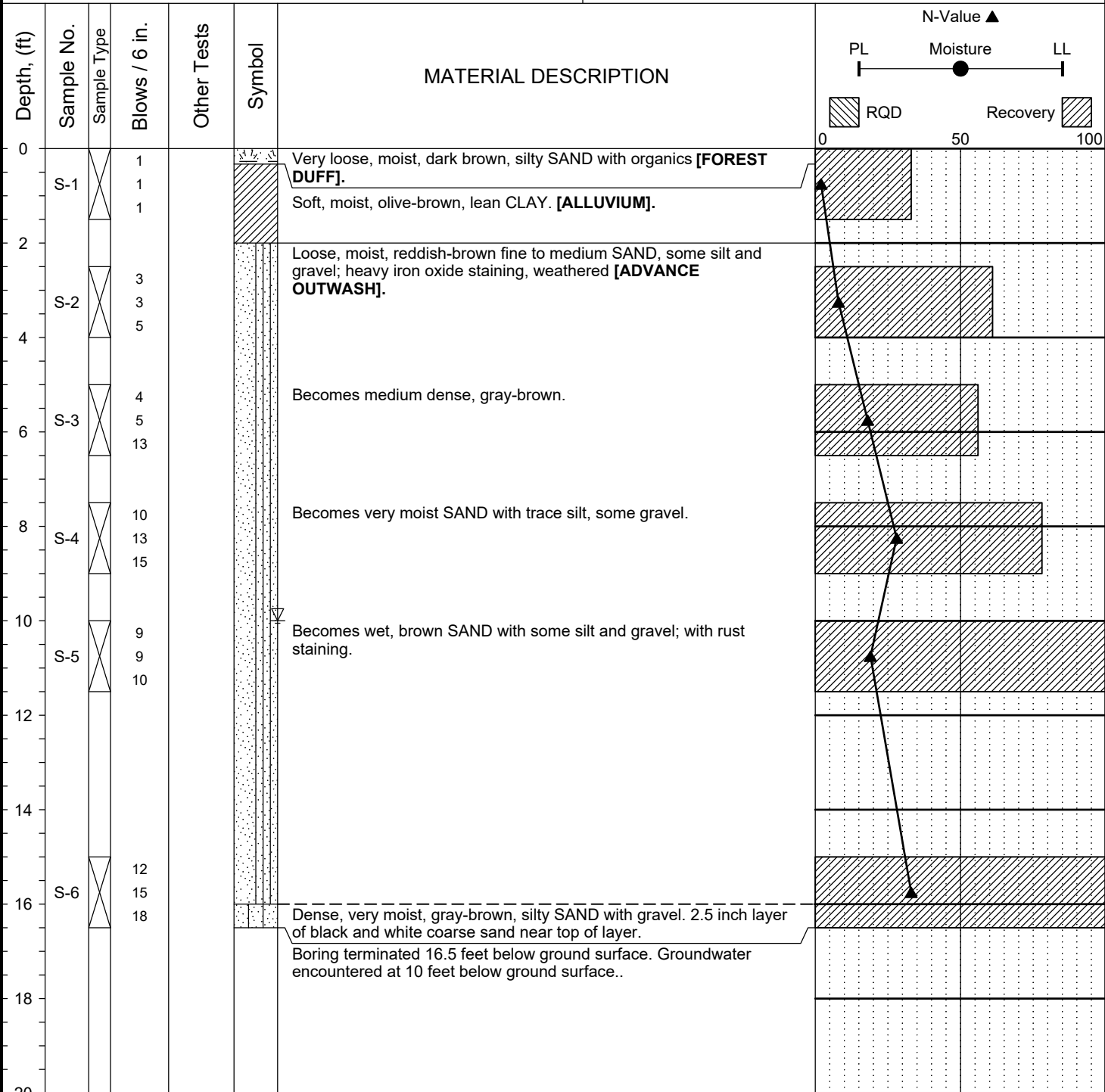

Completion Depth:	16.5ft	Remarks: Boring was drilled with an Acker portable drill rig. Standard Penetration Test (SPT) sampler driven with a 140 lb hammer using a rope and cathead dropping 30 inches per stroke.
Date Borehole Started:	5/11/17	
Date Borehole Completed:	5/11/17	
Logged By:	Bjarni Kristjansson	
Drilling Company:	CN Drilling	



Project:	Mills Property, Mercer Island	Surface Elevation:	264.0ft
Job Number:	17-143.100	Top of Casing Elev.:	N/A
Location:	8440 Southeast 53rd Place	Drilling Method:	HSA
Coordinates:	Northing: , Easting:	Sampling Method:	SPT

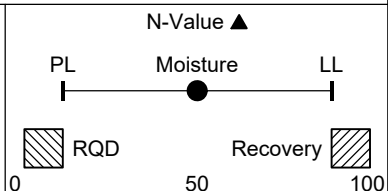
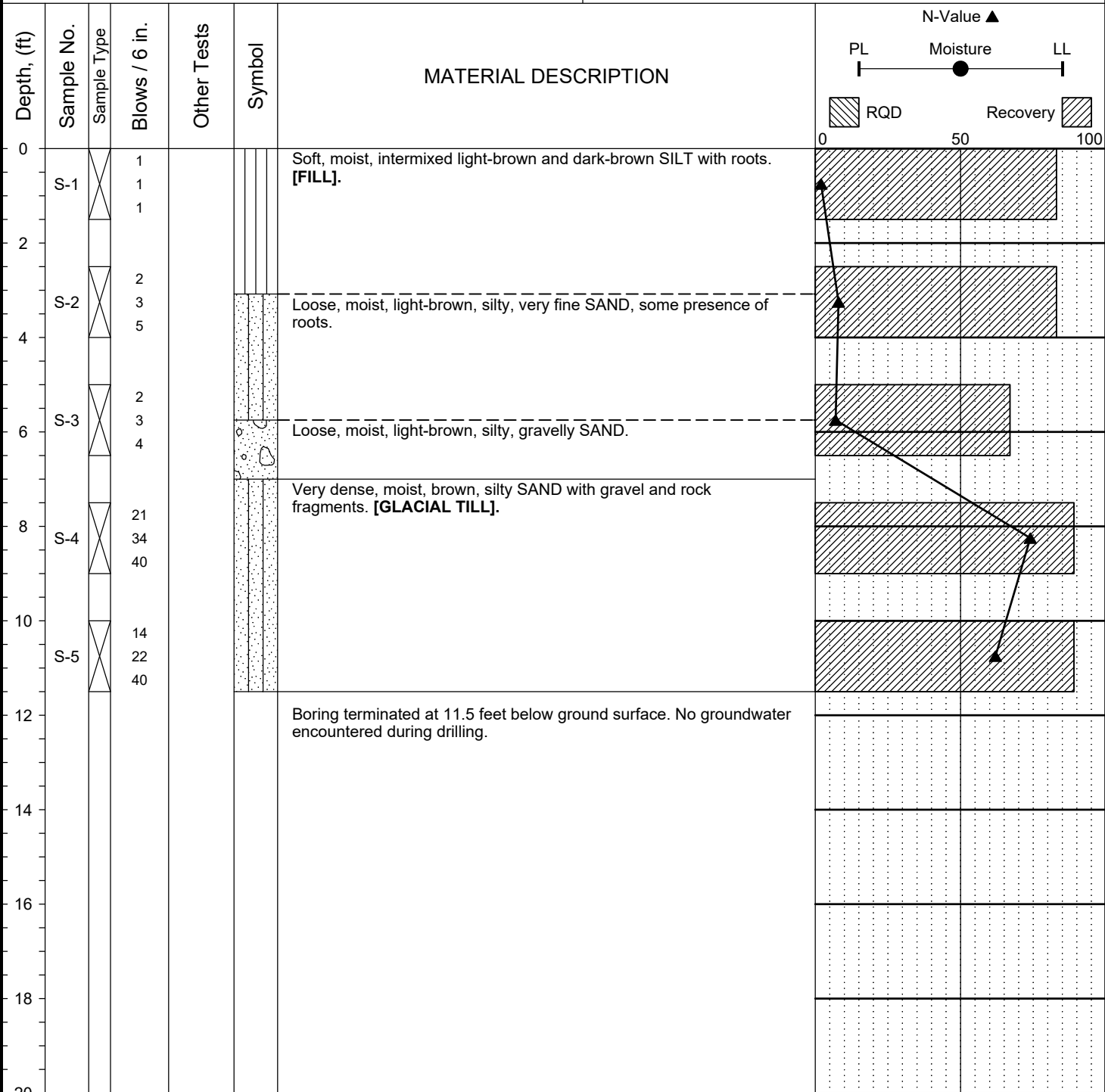

Completion Depth: 11.5ft  
 Date Borehole Started: 5/11/17  
 Date Borehole Completed: 5/11/17  
 Logged By: Bjarni Kristjansson  
 Drilling Company: CN Drilling

Remarks: Boring was drilled with a Acker portable drill rig. Standard Penetration Test (SPT) sampler driven with a 140 lb hammer using a rope and cathead dropping 30 inches per stroke.



### LOG OF TEST BORING PG-5

Figure A-6

The stratification lines represent approximate boundaries. The transition may be gradual.

Project:	Mills Property, Mercer Island	Surface Elevation:	269.0ft
Job Number:	17-143.100	Top of Casing Elev.:	N/A
Location:	8440 Southeast 53rd Place	Drilling Method:	HSA
Coordinates:	Northing: , Easting:	Sampling Method:	SPT

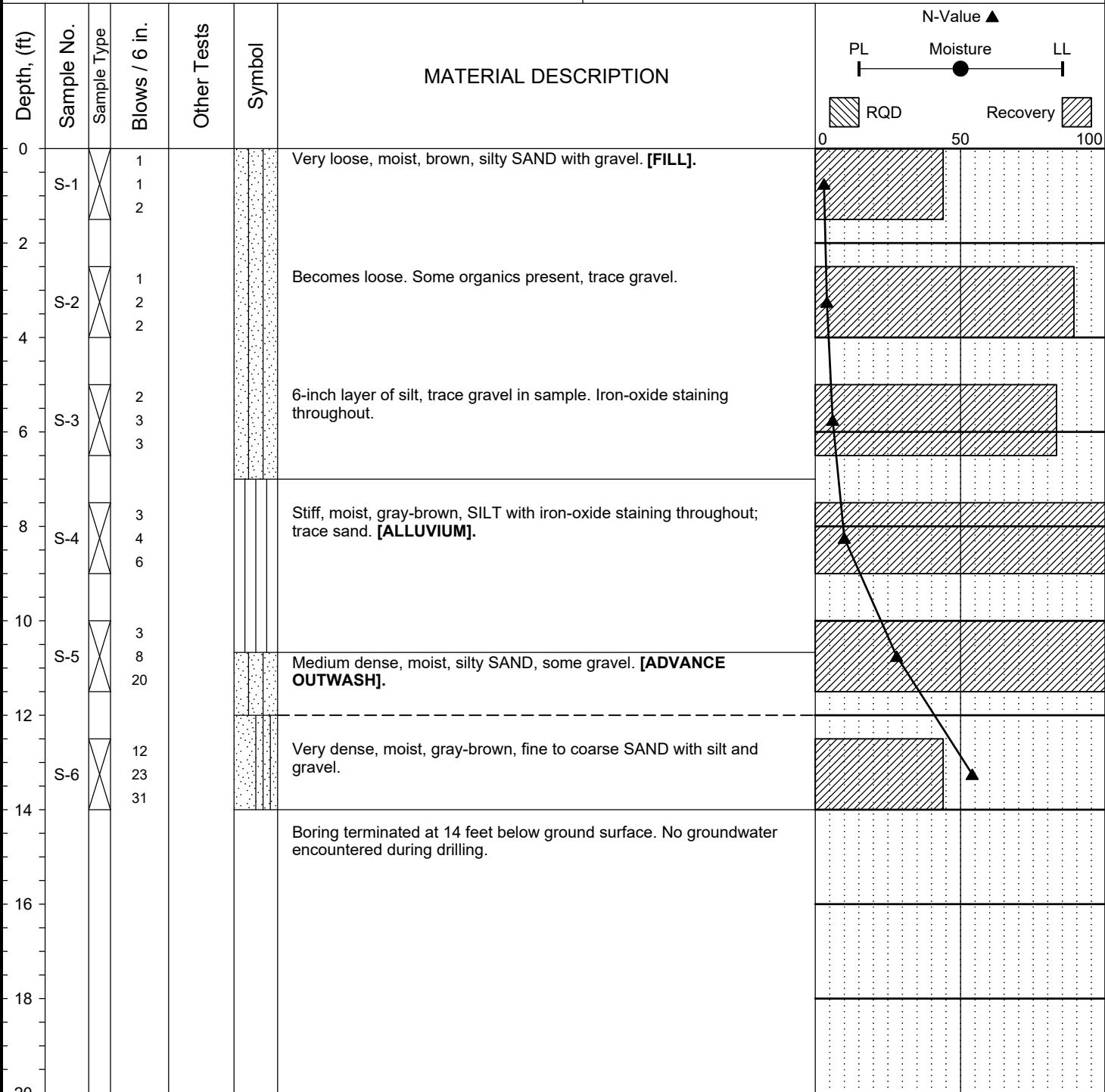

Completion Depth:	14.0ft	Remarks: Boring was drilled with a Acker portable drill rig. Standard Penetration Test (SPT) sampler driven with a 140 lb hammer using a rope and cathead dropping 30 inches per stroke.
Date Borehole Started:	5/11/17	
Date Borehole Completed:	5/11/17	
Logged By:	Bjarni Kristjansson	
Drilling Company:	CN Drilling	



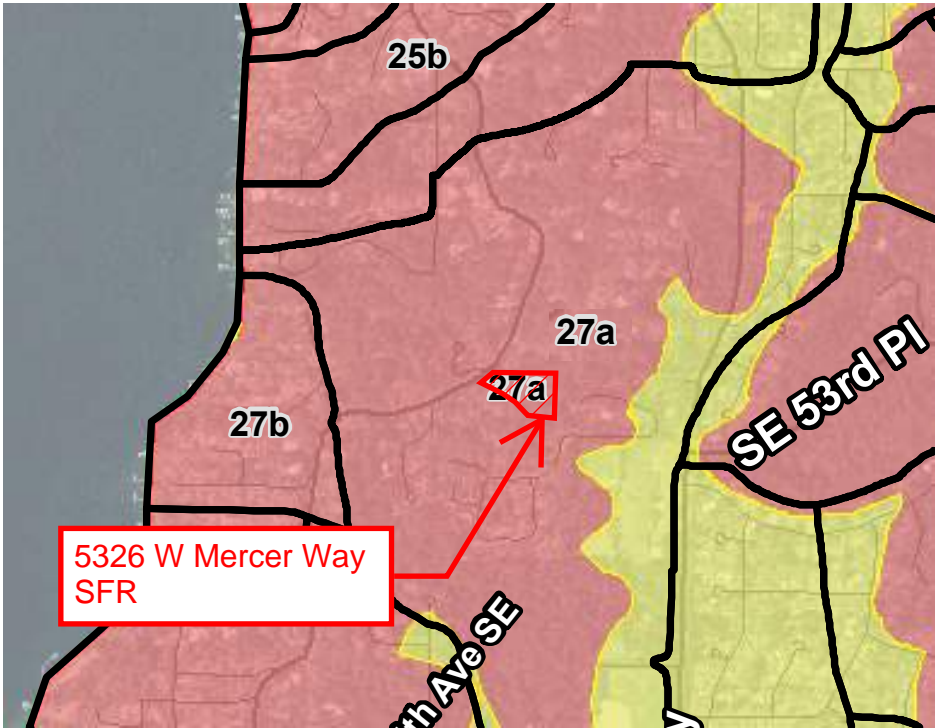

## APPENDIX E

### LOW IMPACT DEVELOPMENT INFILTRATION FEASIBILITY ON MERCER ISLAND

**Figure 3. Low impact development infiltration feasibility on Mercer Island.**



**Legend**

-  Infiltrating LID facilities may be feasible, and soil has high infiltration potential
-  Infiltrating LID facilities may be feasible, and soil has moderate infiltration potential
-  Infiltrating LID facilities are not permitted
-  Storm drainage basin

\* Map is intended to be used for planning purposes only. Site-specific analysis is required prior to design and construction of LID facilities.